

# NORD-10/NORD-50 Operator's Guide

ND—30.001

## NORSK DATA A.S

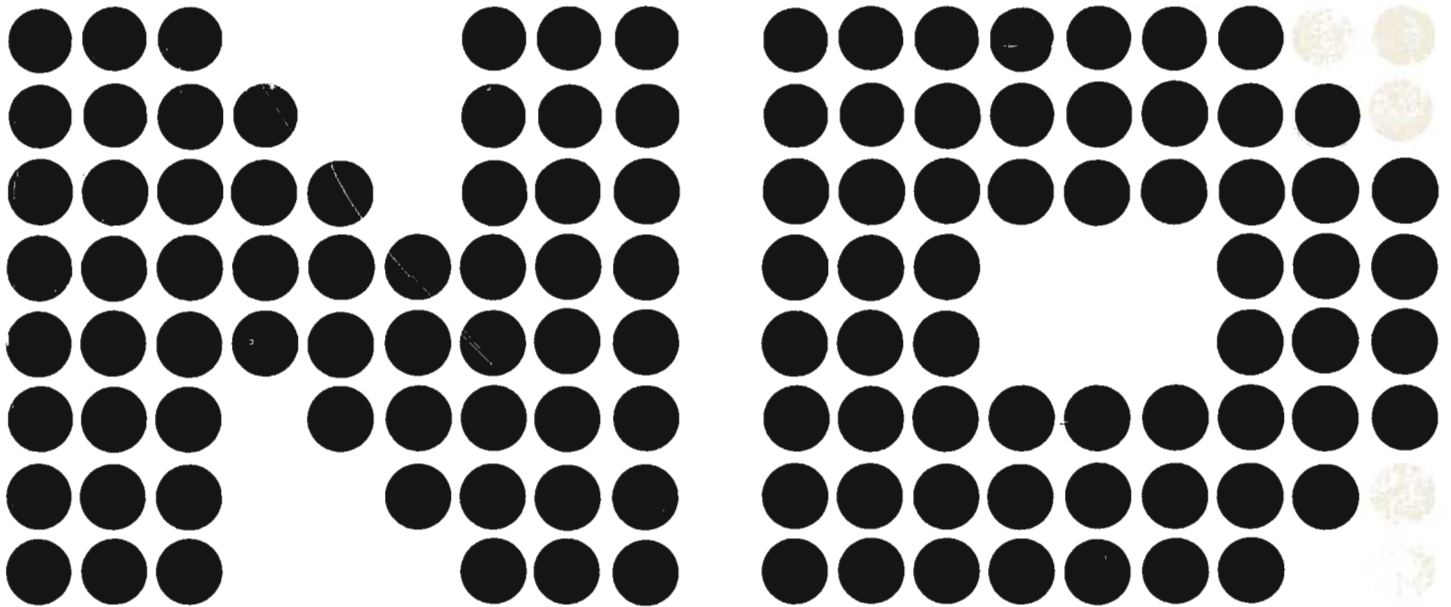



# **NORD-10/NORD-50 Operator's Guide**

**ND—30.001**

**NOTICE**

The information in this document is subject to change without notice. Norsk Data A.S assumes no responsibility for any errors that may appear in this document. Norsk Data A.S assumes no responsibility for the use or reliability of its software on equipment that is not furnished or supported by Norsk Data A.S.

The information described in this document is protected by copyright. It may not be photocopied, reproduced or translated without the prior consent of Norsk Data A.S.

Copyright © 1982 by Norsk Data A.S.

This manual is in loose leaf form for ease of updating. Old pages may be removed and new pages easily inserted if the manual is revised.

The loose leaf form also allows you to place the manual in a ring binder (A) for greater protection and convenience of use. Ring binders with 4 rings corresponding to the holes in the manual may be ordered in two widths, 30 mm and 40 mm. Use the order form below.

The manual may also be placed in a plastic cover (B). This cover is more suitable for manuals of less than 100 pages than for large manuals. Plastic covers may also be ordered below.

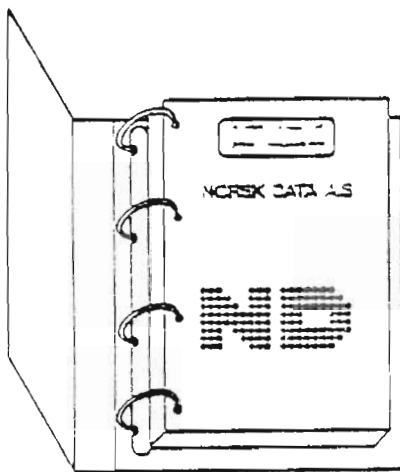

A Ring Binder

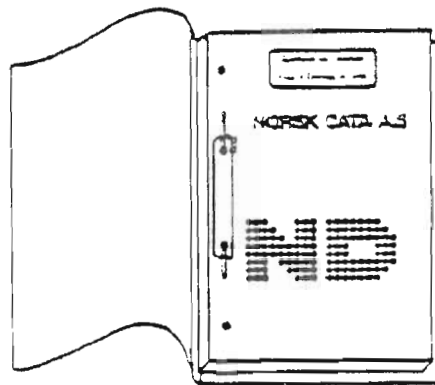

B Plastic Cover

Please send your order to the local ND office or (in Norway) to:

Documentation Department  
Norsk Data A.S  
P.O. Box 4, Lindeberg gård  
Oslo 10

---

## ORDER FORM

I would like to order

..... Ring Binders, 30 mm, at nkr 20,- per binder

..... Ring Binders, 40 mm, at nkr 25,- per binder

..... Plastic Covers at nkr 10,- per cover

Name .....

Company .....

Address .....

.....

City .....



## PRINTING RECORD

Printing	Notes
08/79	ORIGINAL PRINTING
05/82	REVISION A
	The following pages have been revised or added:
	v, vi, vii, viii, ix, x, xi, 1-3, 1-4, 1-12, 1-15, 1-22, 1-23, 1-24, 1-25
	1-26, 1-27,
	2-3, 2-6,
	3-1, 3-2, 3-5, 3-15, 3-27, 3-28, 3-29, 3-30, 3-31
	4-1, 4-3, 4-3A, 4-5, 4-9, 4-10, 4-19, 4-22
	A-1, B-1, B-2, D-1, 1, 2, 3, 4, 5

NORD-10/NORD-50 Operator's Guide  
 ND-30.001.01



NORSK DATA A.S.  
 P.O. Box 4, Lindeberg gård  
 Oslo 10, Norway

Manuals can be updated in two ways, new versions and revisions. New versions consist of a complete new manual which replaces the old manual. New versions incorporate all revisions since the previous version. Revisions consist of one or more single pages to be merged into the manual by the user, each revised page being listed on the new printing record sent out with the revision. The old printing record should be replaced by the new one.

New versions and revisions are announced in the ND Bulletin and can be ordered from the Documentation Department as described below.

The reader's comments form at the back of this manual can be used both to report errors in the manual and to give an evaluation of the manual. Both detailed and general comments are welcome.

These forms, together with all types of inquiry and requests for documentation should be sent to:

Documentation Department  
Norsk Data A.S  
P.O. Box 4, Lindeberg gård  
Oslo 10



## PREFACE

### THE PRODUCT

This manual describes the products:

ND 020	NORD-10/S CPU
ND 050	NORD-50 CPU

together with:

ND 022	NORD-10/S Operator's Panel
--------	----------------------------

These CPUs are used in ND 1100/S, ND 1200/S, ND 1300/S and ND 1400/S systems. Includes cabinet and power supply for CPU, memory, device interfaces, power fail interrupt, and automatic restart. Systems with 8 Kw/18 bit MOS memory modules and ND 140 Multiport Memory have memory parity check. Systems with 32 Kw/21 bit memory modules and ND 143, ND 144 or ND 146 Multiport Memory have automatic error correction.

Note that ND 1200/S systems using 32 Kw memory modules do not require multiport memory because memory modules are mounted in the CPU rack.

CPU options:

ND 011	Memory Management System
ND 021	CACHE Memory
ND 019	Commercial Instruction Set - 48 bit format
ND 022	Operator's Panel
ND 023	Programmable Real-Time Clock
ND 024	Conversion from ND 019 to ND 025
ND 025	COBOL Microprogram — 32 bit format

### THE READER

This manual is an introduction to the operation and maintenance of the NORD-10/S and the NORD-50. It is written mainly for operators who need basic information about how to run the NORD-10/S and NORD-50 and how to handle simple error situations.

More experienced operators who manage and control NORD-10/NORD-50 installations, including both the hardware and the SINTRAN III operating system, are termed system supervisors. Detailed information for system supervisors is given in the SINTRAN III System Supervisor's Guide, but system supervisors may want to read this manual first as an introduction to the other manual.

*PREREQUISITE KNOWLEDGE*

No previous knowledge of NORD computers is necessary for understanding this manual. However, the reader should be familiar with the general principles of computer operation and preferably have some experience in this field.

*THE MANUAL*

This manual contains both introductory and reference information. Chapters of interest should be read sequentially first before being used as reference information.

Chapters 1-3 cover the operation and maintenance of NORD-10/S. Chapter 1 is a general introduction to the material, chapter 2 describes the operation and chapter 3 the maintenance, including both preventive maintenance and the handling of error situations. Chapter 4 contains information about operating and maintaining the NORD-50. This material is presented separately from the NORD-10/S material because many installations have only NORD-10/S. A short description of the information available in other manuals on the NORD-10/S and NORD-50 is given in Appendix A.

*RELATED MANUALS*

Other manuals of interest to the readers of this manual are:

SINTRAN III System Supervisor's Guide	ND--30.003
NORD-10/S General Description	ND--06.013
NORD-10/S Functional Description	ND--06.009
NORD-10/S Input/Output System	ND--06.012
NORD--10/S Maintenance Manual	ND--30.004
Test Program Descriptions	ND--30.005
NORD-10/NORD-50 Communication System	ND--06.005
NORD-50 General Description	ND--05.008
NORD-50 Functional Description	ND--05.007
NORD--50 Maintenance Manual	ND--30.010
NORD-50 Test System	ND--30.007

These manuals are described in Appendix A, Documentation Review. In addition, every computer will have one loose leaf book containing information about that special computer hardware configuration and one with information about the software.

## TABLE OF CONTENTS

+ + +

<i>Section:</i>	<i>Page:</i>
1	INTRODUCTION TO THE NORD-10/S .....1-1
1.1	General Characteristics .....1-1
1.2	Specifications and Performance Characteristics .....1-3
1.2.1	Processor .....1-3
1.2.2	Memory .....1-3
1.2.3	Interrupt System .....1-3
1.2.4	I/O System .....1-4
1.2.5	Physical .....1-4
1.2.6	Environmental .....1-4
1.3	System Architecture .....1-5
1.3.1	Single-Processor System .....1-5
1.3.2	Multi-Processor Systems .....1-7
1.3.3	Remote Operation .....1-10
1.4	Construction Principles .....1-12
1.4.1	Cabinet Overview .....1-13
1.4.2	NORD-10/S Layout .....1-14
1.4.3	NORD-10 115/230 Volts Mains Distribution .....1-15
1.4.4	NORD-10 5V and 24V Distribution .....1-16
1.4.5	NORD-10 Fans Location and Air Flow .....1-17
1.5	Power Unit .....1-18
1.5.1	General .....1-18
1.5.2	Control Panel Description .....1-20
1.5.2.1	Indicators .....1-20
1.5.2.2	Switches .....1-21
1.5.2.3	Adjustments .....1-22
1.5.3	Power Fail/Automatic Restart .....1-24
1.6	Plug Panel .....1-25

<i>Section:</i>	<i>Page</i>
2	OPERATING THE NORD-10/S.....2-- 1
2.1	Introduction .....2-- 1
2.2	The Operator's Panel..... 2--3
2.2.1	Panel Elements.....2--3
2.2.2	Power On/Off Button .....2--3
2.2.3	Panel Key Lock.....2--3
2.2.4	Control Buttons .....2--4
2.2.5	Display Level Select.....2--6
2.2.6	Mode Indicators .....2-- 6
2.2.7	18-Bit Switch Register .....2-- 6
2.2.8	18-Bit Light Register .....2--7
2.2.9	16 Selector Push-Buttons and 16 Associated Lights.....2--7
2.3	The Console Terminal..... 2--9
2.3.1	Functions .....2--10
2.3.2	Bootstrap Loaders.....2-- 16
2.4	Starting and Stopping a NORD-10/S.....2--20
2.4.1	Starting Up Procedure .. .....2--20
2.4.2	When To Stop a NORD-10/S.....2--21
3	PREVENTATIVE MAINTENANCE AND ERROR HANDLING .....3--1
3.1	Preventative Maintenance .....3--1
3.1.1	Maintenance To Be Done By The Owner .....3-- 1
3.1.2	Maintenance To Be Done By The ND Service Department .....3-- 2
3.2	System Failures .....3-- 3
3.3	Error Procedures For Fatal Errors.....3-- 4
3.3.1	Computer "Hanging" Procedure .....3--4
3.3.2	Computer "Dead" Procedure .....3--5
3.3.3	Start/Restart Procedure.....3-- 6
3.4	Error Messages From SINTRAN III Monitor .....3-- 7
3.4.1	Error Message Format .....3-- 7
3.4.2	Error Number Summary.....3-- 8
3.4.3	System Actions And Operator Responses .....3--11

<i>Section:</i>	<i>Page:</i>
3.5	Error Messages From SINTRAN III File System ..... 3—23
3.6	Test And Utility Programs ..... 3—27
3.6.1	Test Program Summary ..... 3—28
3.6.2	Memory Test By Using The Microprogram ..... 3—31
4	THE NORD-50 COMPUTER SYSTEM ..... 4—1
4.1	Introduction ..... 4—1
4.1.1	Specifications and Performance Characteristics ..... 4—3
4.2	NORD-50 Computer System Architecture ..... 4—4
4.2.1	Basic Configuration ..... 4—4
4.2.2	Multiple NORD-50 Configurations ..... 4—4
4.2.3	A Multiple Configuration Example ..... 4—6
4.2.4	NORD-50 Construction Principles ..... 4—9
4.2.5	NORD-50 Crates ..... 4—13
4.2.6	The NORD-50 CPU ..... 4—14
4.2.7	NORD-10/NORD-50 Connections ..... 4—15
4.2.8	NORD-50 Memory Connections ..... 4—16
4.3	NORD-50 Operator's Panel ..... 4—18
4.3.1	Lights ..... 4—18
4.3.2	Push Buttons And Key ..... 4—19
4.4	NORD-50 Monitor ..... 4—21
4.4.1	Command Summary ..... 4—21
4.5	NORD-50 Maintenance ..... 4—22
4.5.1	Test Programs Running In The NORD-10/S ..... 4—23
4.5.2	Tests Running In The NORD-50 ..... 4—24
4.5.3	Verification Programs ..... 4—24
4.5.4	NORD-50 Test-Sequence ..... 4—25

<i>Appendix:</i>		<i>Page:</i>
A	DOCUMENTATION REVIEW .....	A-1
B	TEST PROGRAM OVERVIEW .....	B-1
C	NORD-50 TEST PROGRAMS .....	C-1
C.1	TEST-MEM Monitor Command .....	C-1
C.2	TMEM Memory Test Program .....	C-2
C.3	Verification Programs .....	C-3
D	PARTS LIST.....	D-1
INDEX	.....	-1-

## LIST OF ILLUSTRATIONS

<i>Figure:</i>		<i>Page:</i>
1.1	Medium Sized NORD-10/S Computer System.....	1—5
1.2	NORD-10/S two-processor system.....	1—8
1.3	NORD-10/S four-processor system.....	1—9
1.4	Remote load from master CPU.....	1—10
1.5	Remote load via telephone line and HDLC protocol.....	1—11
1.6	Cabinet overview (NORD-10/S).....	1—13
1.7	NORD-10/S layout.....	1—14
1.8	NORD-10 115/230 volts mains distribution.....	1—15
1.9	NORD-10 5V and 24V distribution.....	1—16
1.10	NORD-10 fans location and air flow.....	1—17
1.11	NORD power unit 10, mechanical layout.....	1—19
1.12	NORD power unit panel.....	1—23
1.13	Internal cables.....	1—26
1.14	Plug panel details.....	1—27
2.1	Operator's panel.....	2—2
4.1	Single NORD-50 configuration.....	4—5
4.2	Dual NORD-50 configuration.....	4—5
4.3	System configuration, F-16.....	4—7
4.4	Processor connections, F-16.....	4—8
4.5	Cabinet overview (NORD 50).....	4—10
4.6	NORD-10 — NORD-50 configuration.....	4—11
4.7	Power distribution in F-16 configuration.....	4—12
4.8	Operator's panel (NORD-50).....	4—20
 <i>Table:</i>		 <i>Page:</i>
2.1	ALD setting.....	2—19





# 1 INTRODUCTION TO THE NORD-10/S

## 1.1 GENERAL CHARACTERISTICS

The NORD-10/S computer system is a medium scale general purpose computer system which, because of the modular design, is actually a family of computer systems.

A basic instruction set is common to all NORD-10/S machines, and this set is highly optimized to produce effective code; hardware floating point arithmetic is standard as are the instructions to manipulate individual bits at high speed.

The register structure and addressing scheme facilitate the processing of structured data with high efficiency.

The NORD-10/S is micro-programmed, and all NORD-10/S instructions are executed by means of a micro-program located in a very fast (65 ns) read-only memory. Micro-programming gives the NORD-10/S computer flexibility and a very large growth potential. New instructions may be added to the NORD-10/S and instructions for special applications may be optimized for a particular use.

The NORD-10/S provides up to 1024 customer-specified instructions. These instructions are micro-programmed in a programmable read-only memory, which is added onto the standard read-only memory.

Micro-programming in NORD-10/S is also used to control the operator's panel and to perform operator communication between the operator and the console teletype or display.

Bootstrap loaders, both for character oriented devices and mass storage devices are also controlled by a micro-program.

The NORD-10/S is designed to be equipped with a wide range of main memories. Memory size may vary from 1K to 256K 16-bit words, and both read-only memories and read/write memories may be used. The speed range is from a high-speed bipolar memory of 100 ns cycle time to core memories, which require 900 ns cycle time.

Standard memory type is MOS semiconductor memory with a cycle time of 400ns. Parity checking with a parity bit for each byte is standard, while memory error correction with 21 bit memory modules is optional.

As an option, the NORD-10/S CPU may be equipped with 1K words of bipolar cache memory, which significantly increases the CPU performance.

The speed of the NORD-10/S standard processor is 260 ns per micro-instruction, and the NORD-10/S CPU will make efficient use of main memories with a cycle time of 300 ns.

The input/output and interrupt systems of **NORD-10/S** are designed for ease of use and very high speed. **NORD-10/S** has 16 program levels, each with its own set of registers, making possible a complete context switching from one program level to another in only 1  $\mu$ s. In addition, **2048** priority vectored interrupts are standard, as well as **10** priority internal hardware status interrupts.

As an option, the **NORD-10/S** may have a memory management system which includes a paging system which performs program relocation, dynamic memory allocation and ring protection and memory protection systems.

## 1.2 SPECIFICATIONS AND PERFORMANCE CHARACTERISTICS

### 1.2.1 Processor

Microprocessor cycle time:	260 ns
16 bit parallel processor, 32 bit parallel arithmetic during floating operation	
CACHE memory size:	1K/25 bits
Paging overhead with CACHE:	0%
Paging overhead without CACHE:	10%
Access time for the Page Table:	150 ns
Access time for the CACHE memory:	150 ns

### 1.2.2 Memory

Maximum virtual memory address space:	128 Kbytes
Maximum physical memory address space:	512 Kbytes
Access time for Local Memory:	380 ns
Cycle time for Local Memory:	400 ns
Access time for Multiport Memory:	435 ns
Cycle time for Multiport Memory:	450 ns
Parity:	2 bits — one per byte
Error Checking and Correcting Memory:	21 bits, single bit detection and correction (40% of all double bit errors detected)
Battery stand by power for memory:	Maximum 15 minutes

### 1.2.3 Interrupt System

16 priority interrupt levels each with 8 registers	
Context block switching time:	1 $\mu$ s
External Interrupt Identification time:	2 $\mu$ s minimum 2.3 $\mu$ s average

## 1.2.4 *I/O System*

Maximum DMA rate/channel to Multiport Memory:	1.6 Mbytes
Maximum transfer rate for Multiport Memory Channel:	2.8 Mbytes
Maximum DMA latency for highest priority devices: refresh + CPU + channel	2.5 $\mu$ s

## 1.2.5 *Physical*

### Dimensions:

Height:	160 cm
Width:	59,5 cm
Depth:	60,5 cm
Volume:	0.576 m <sup>3</sup>
Weight:	100 kg
Power:	220V AC $\pm$ 0% (or 115V AC) 50 Hz $\pm$ 2 Hz 2.7 Amp @220V*
Cooling:	Forced cooling
Operating Ambient Temperature:	0 - 55 <sup>o</sup> C
Operating Humidity:	10 - 90%, non-condensing

- \* Applies to a NORD-10 CPU with: Memory Management System, CACHE, Large disk interface, Bus Receiver, Bus Brancher and 128 Kbytes of MOS Memory.

## 1.2.6 *Environmental Requirements*

These can be found in the Site Preparation and Installation Manual, ND--13.014.

### 1.3 SYSTEM ARCHITECTURE

#### 1.3.1 Single-Processor System

Figure 1.1 shows a typical medium sized NORD-10/S single processor system.

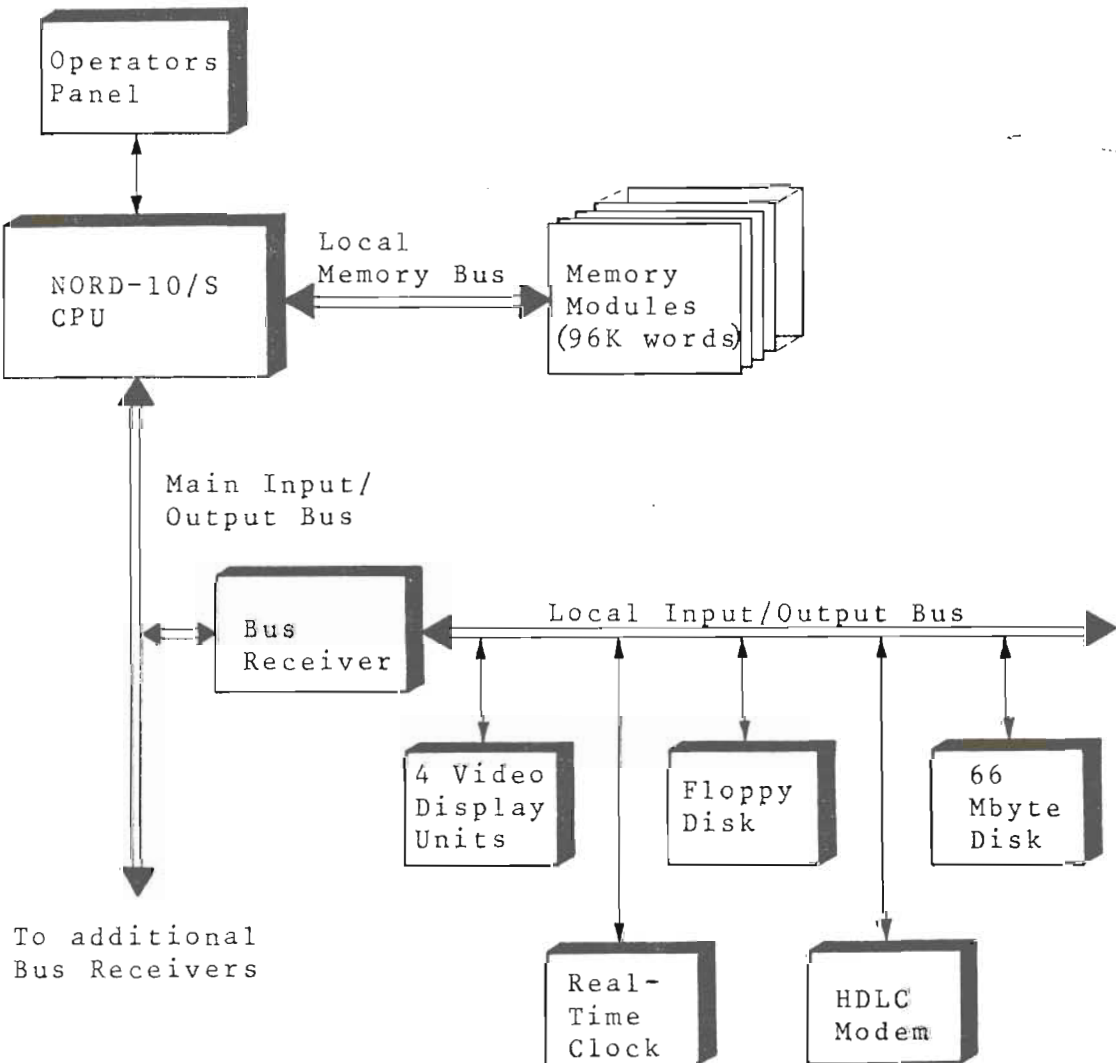

Figure 1.1: MEDIUM SIZED NORD-10/S COMPUTER SYSTEM

In this example, the size of the main memory is 96K 16-bit words, based on 32K MOS semiconductor memory. Details concerning memory flexibility and options are presented in Section 1.3.2.

Parts of the input/output system are shown separated from the rest of the bus receiver which efficiently combines flexibility, simplicity and reliability. The bus receiver provides the necessary fan out and reduces complexity of device control units. Reliability is increased because errors, in most cases, have only limited consequences on the local input/output bus.

An important factor in designing the completely modular input/output system with all device interfaces made to a common standard, has been the frequent field installations of expanded systems. Interface modules plug directly into prewired positions.

Substantial effort was made to prepare the **NORD-10/S** for multi-CPU applications and remotely operated installations.

### 1.3.2 *Multi-Processor Systems*

The NORD-10/S CPU main frame has eight general slots for memory modules, and two slots reserved for optional multiport memory interface buffers.

The following standard memory modules are available for direct connection into each of the eight slots:

- 8K by 18 bits, 300 ns access time
- 8K by 21 bits, 300 ns access time
- 32K by 18 bits, 350 ns access time
- 32K by 21 bits, 350 ns access time
- 32K by 18 bits, 300 ns access time
- 32K by 21 bits, 300 ns access time

Memory modules with 18 bits word length provide one parity bit per byte, while 21 bit modules are used for memory error correction. Maximum memory size addressable from one CPU is 256K words.

The NORD-10/S multi-processor system is shown in Figure 1.2.

Common main memory is connected via the multiport memory interface unit, which is capable of handling requests from both CPUs in parallel if they do not address the same 64K module. The "local" 64K modules shown in the figure may, of course, be omitted; they are shown to demonstrate the flexibility of the system.

The total capacity of the dual memory interface is four independent channels as shown in Figure 1.3.

The memory access priority for the CPUs is normally allocated in a different order for each 64K unit.

By omitting three of the CPUs in Figure 1.3, we obtain a one-processor system with a maximum memory configuration of 256K.

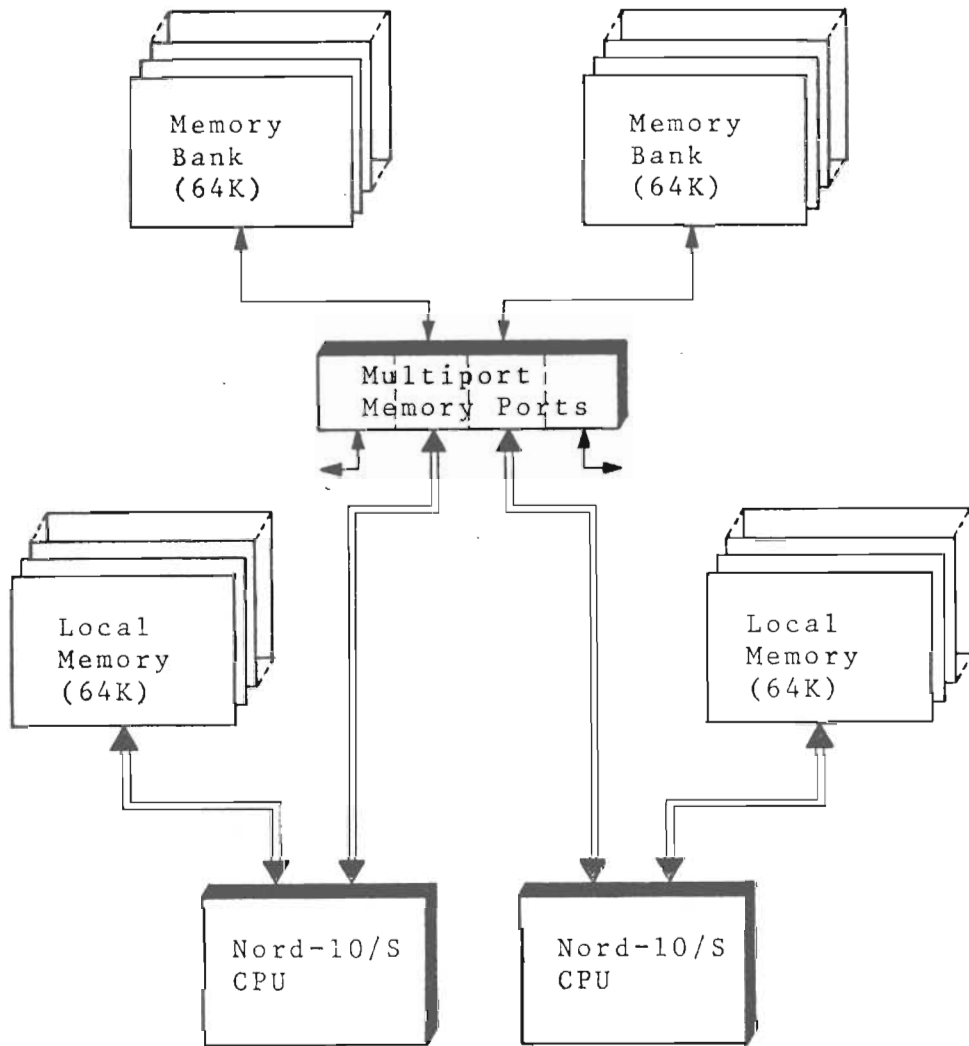

Figure 1.2: NORD-10/S TWO-PROCESSOR SYSTEM



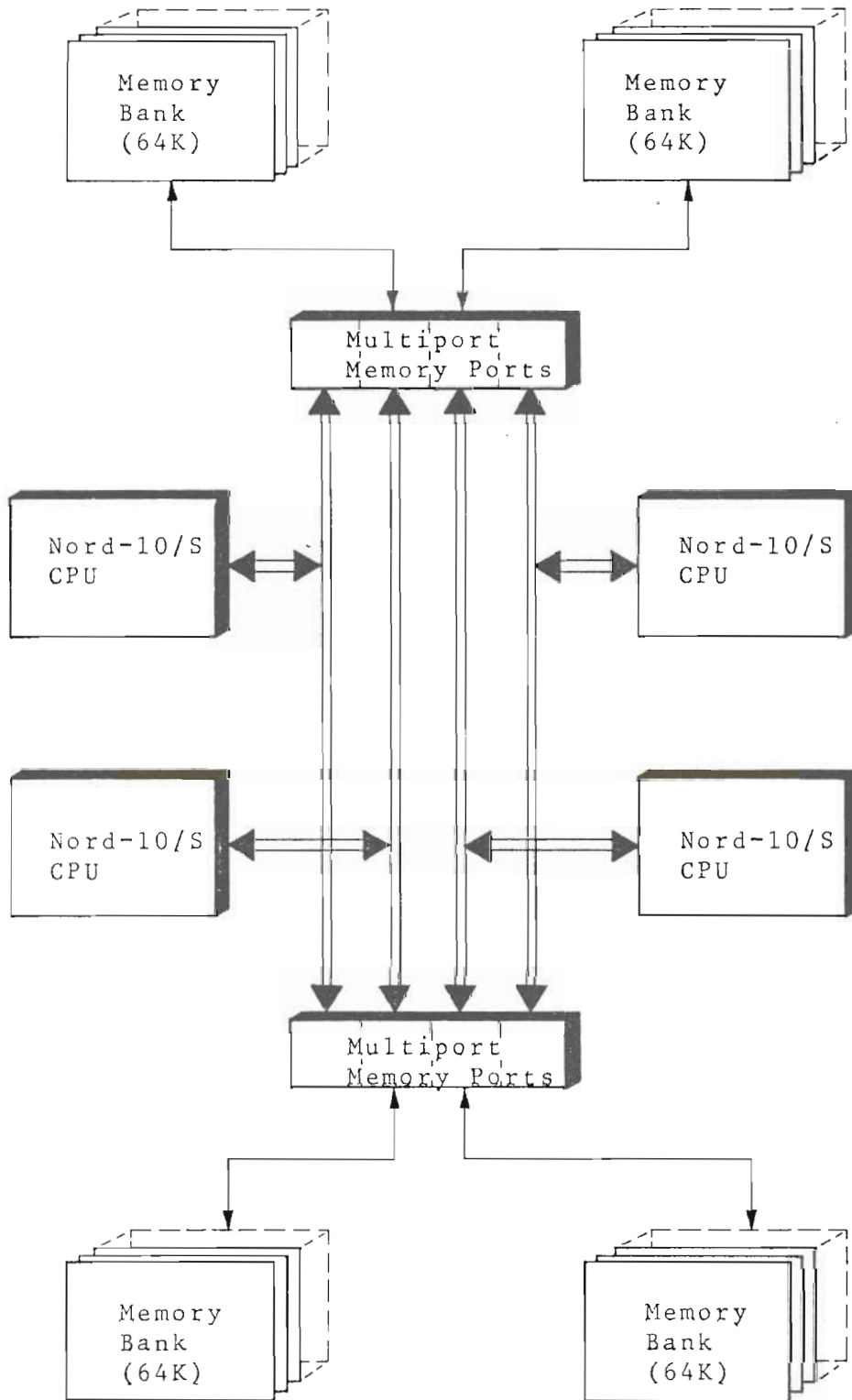

Figure 1.3: NORD-10/S FOUR-PROCESSOR SYSTEM

### 1.3.3 Remote Operation

Several facilities for the remote operation of the NORD-10/S are available. Remote operation here means one NORD-10/S being controlled by another NORD-10/S. In some cases, the two machines may be in the same room, or they are connected over telephone lines using low or high speed modems.

The simplest form of remote operation is shown in Figure 1.4.

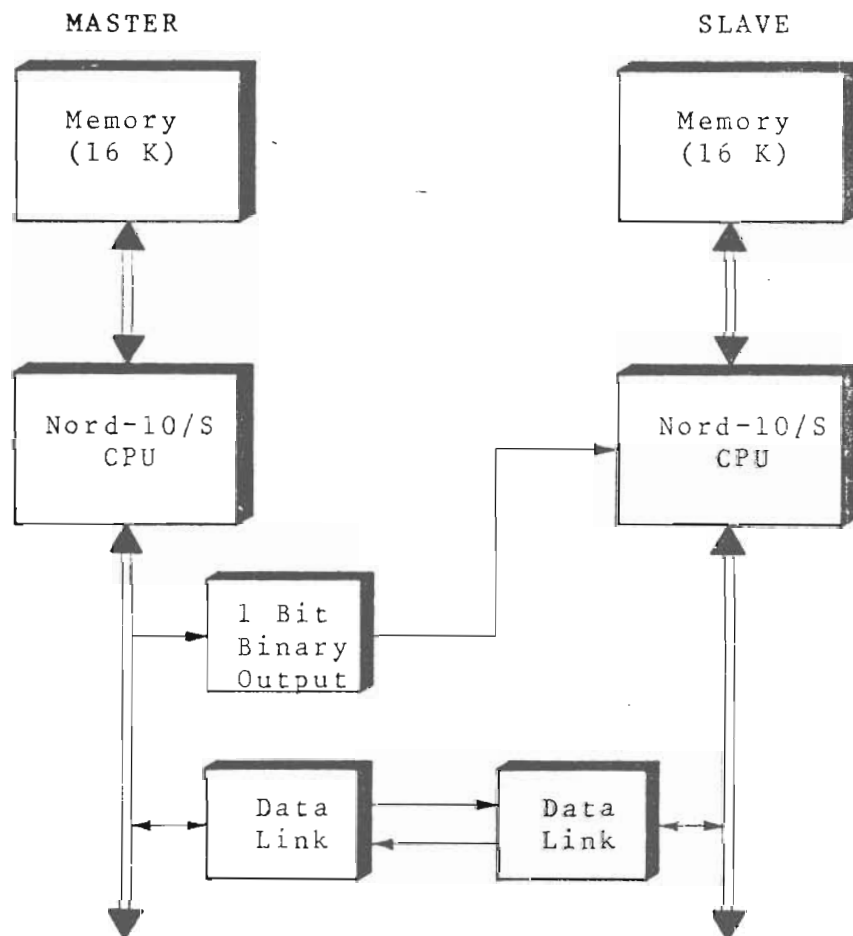

Figure 1.4: REMOTE LOAD FROM MASTER CPU

In this case, the automatic LOAD function built into the micro-programmed control unit of all NORD-10/S CPU's is used to start reading data via the data link.

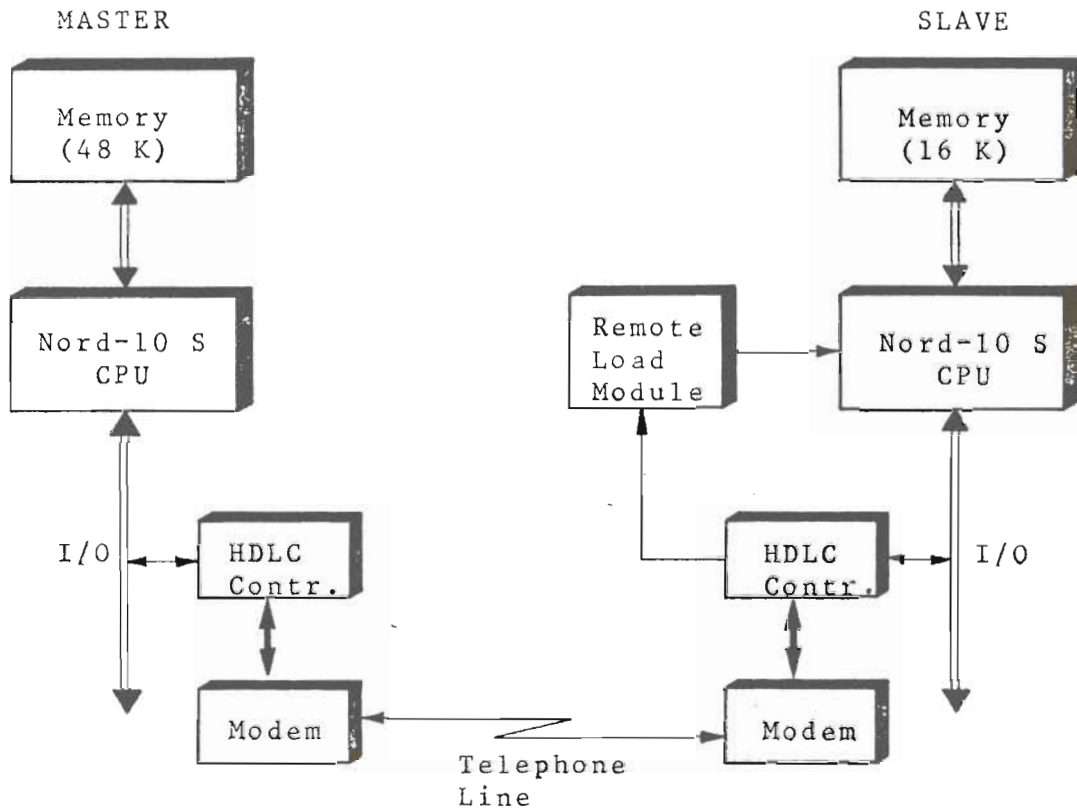

Figure 1.5: EXAMPLE OF REMOTE LOAD VIA TELEPHONE LINE AND HDLC PROTOCOL

In the example shown in Figure 1.5, the slave computer is equipped with a remote load module, which decodes a special "remote load trigger" frame sent by the master computer, thus, activating a load micro-program in the slave. In the example, the HDLC (High-level Data Link Control) communication hardware in the slave computer detects the special data frame and triggers the load procedure. A remote load operation may be initiated both by the master computer and by an operator at the slave computer site.

## 1.4 CONSTRUCTION PRINCIPLES

The following pages contain diagrams showing the general construction of a NORD-10/S, the power distribution and the cooling system. Figure 1.6 gives an overview of the placement of the various components in the cabinet. Then the general layout of the cabinet is shown in Figure 1.7. The next figures show the mains distribution and the 5V and 24V distribution. Finally, the location of the fans and the air flow is shown.

### *WARNING*

*Objects should not be placed on the top of the computer if they can fall through the air holes or hinder air circulation.*

1.4.1 Cabinet Overview

- 1 Top fan, right
- 2 Top fan, left
- 3 Power supply unit no.1
- 4 Operator's panel
- 5 Crate A (CPU crate)
- 6 Fan for crate A
- 7 Formatter for floppy disk
- 8 Floppy driver 1
- 9 Floppy driver 2
- 10 Crate B (I/O crate)
- 11 Crate C (I/O crate)
- 12 Fan for crates B and C
- 13 Power panel if 115V AC
- 14 Power supply unit no.1
- 15 Cross rail no.1
- 16 Terminal no.1
- 17 M1 crate (Multiport memory MPM)
- 18 Fans for M1 crate
- 19 Terminal no.2
- 20 Cross rail no.3
- 21 Formatter for floppy disk
- 22 Frame for plug panel with sub-panels
- 23 Cabinet front side
- 24 Cabinet back side
- 25 Power panel if 230V AC

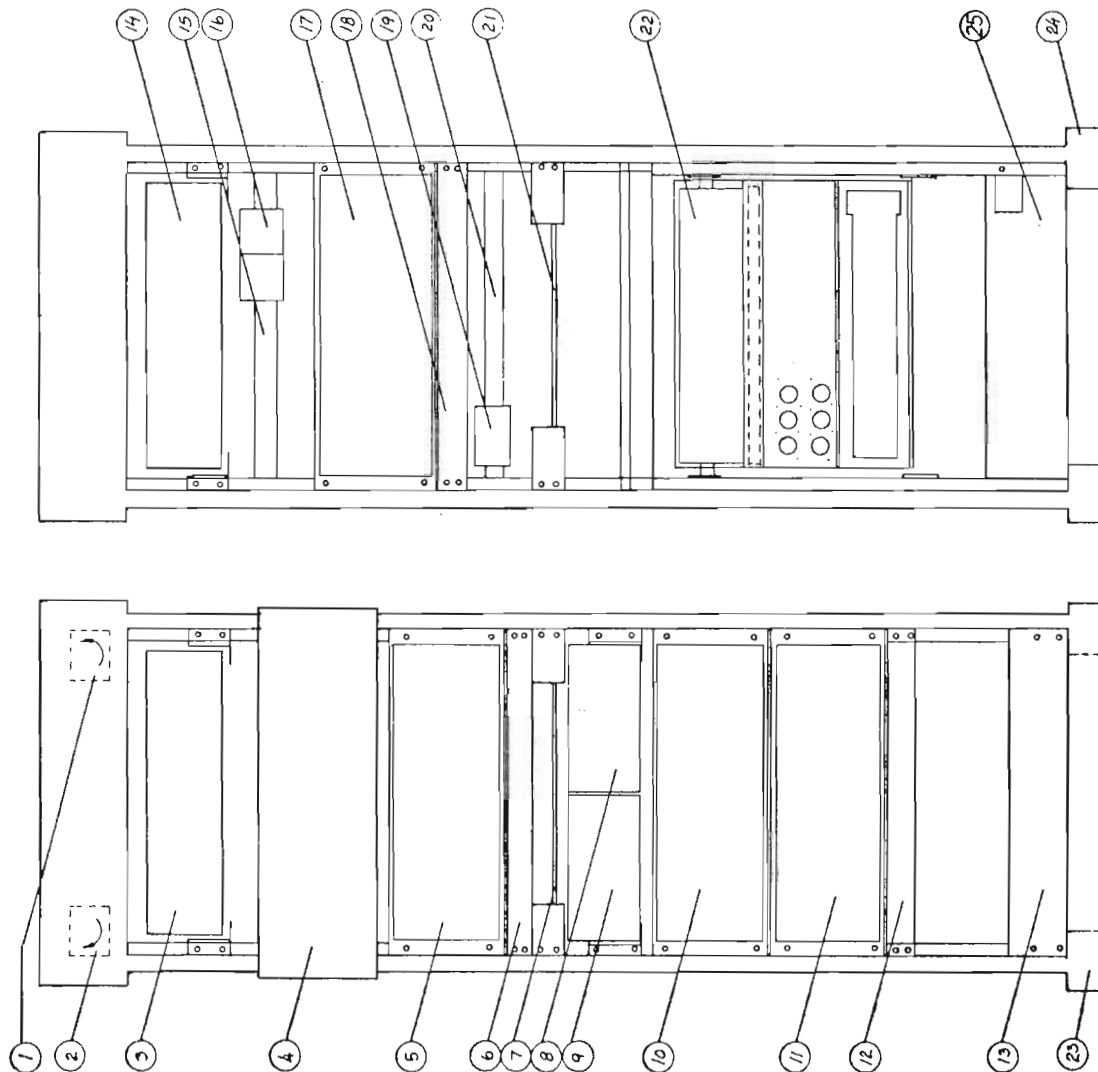

Figure 1.6: CABINET OVERVIEW

1.4.2 *NORD-10/S Layout*

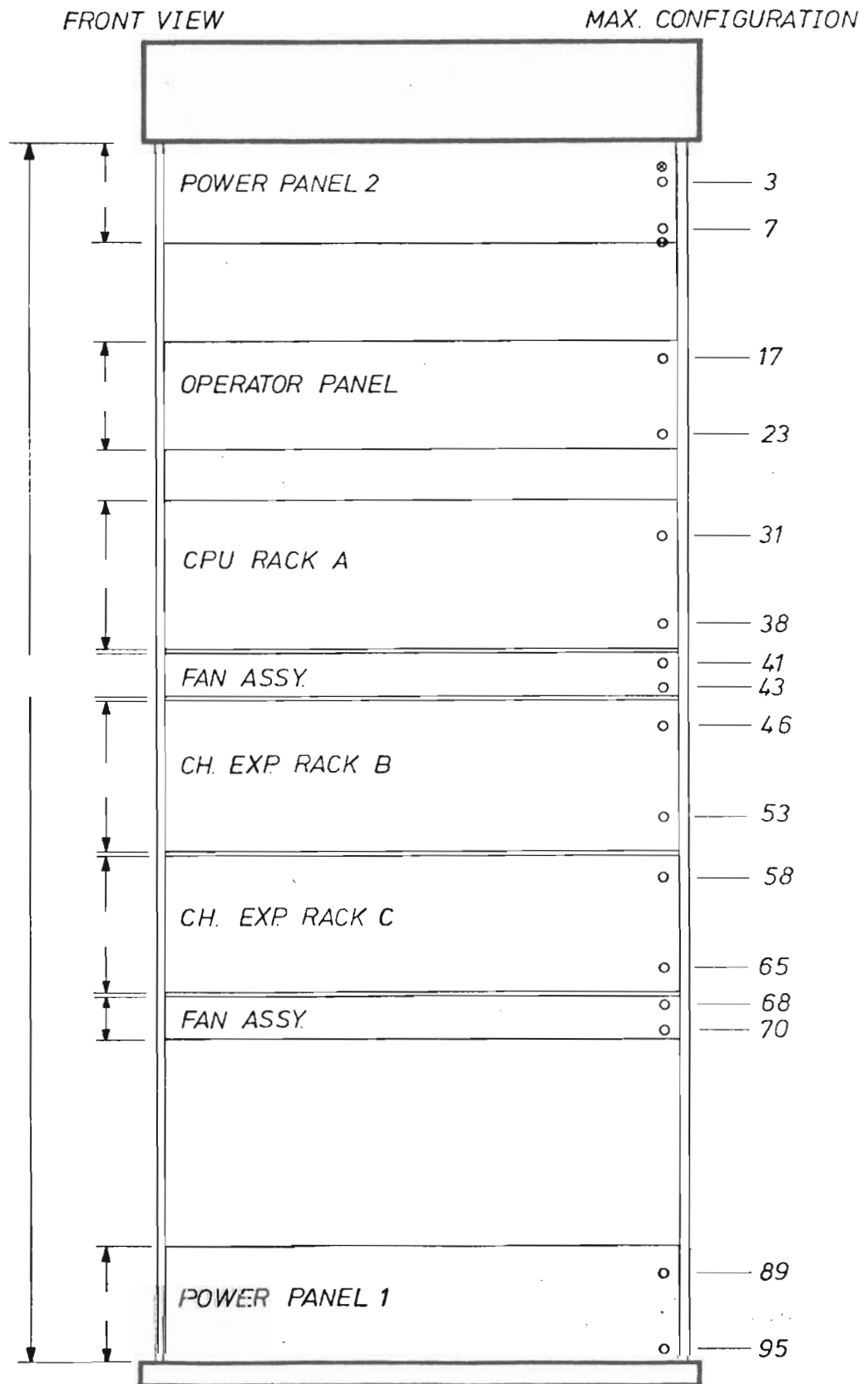

Figure 1.7: NORD 10/S LAYOUT

ND-30.001.01

1.4.3 *NORD-10 115/230 VOLTS MAINS DISTRIBUTION*

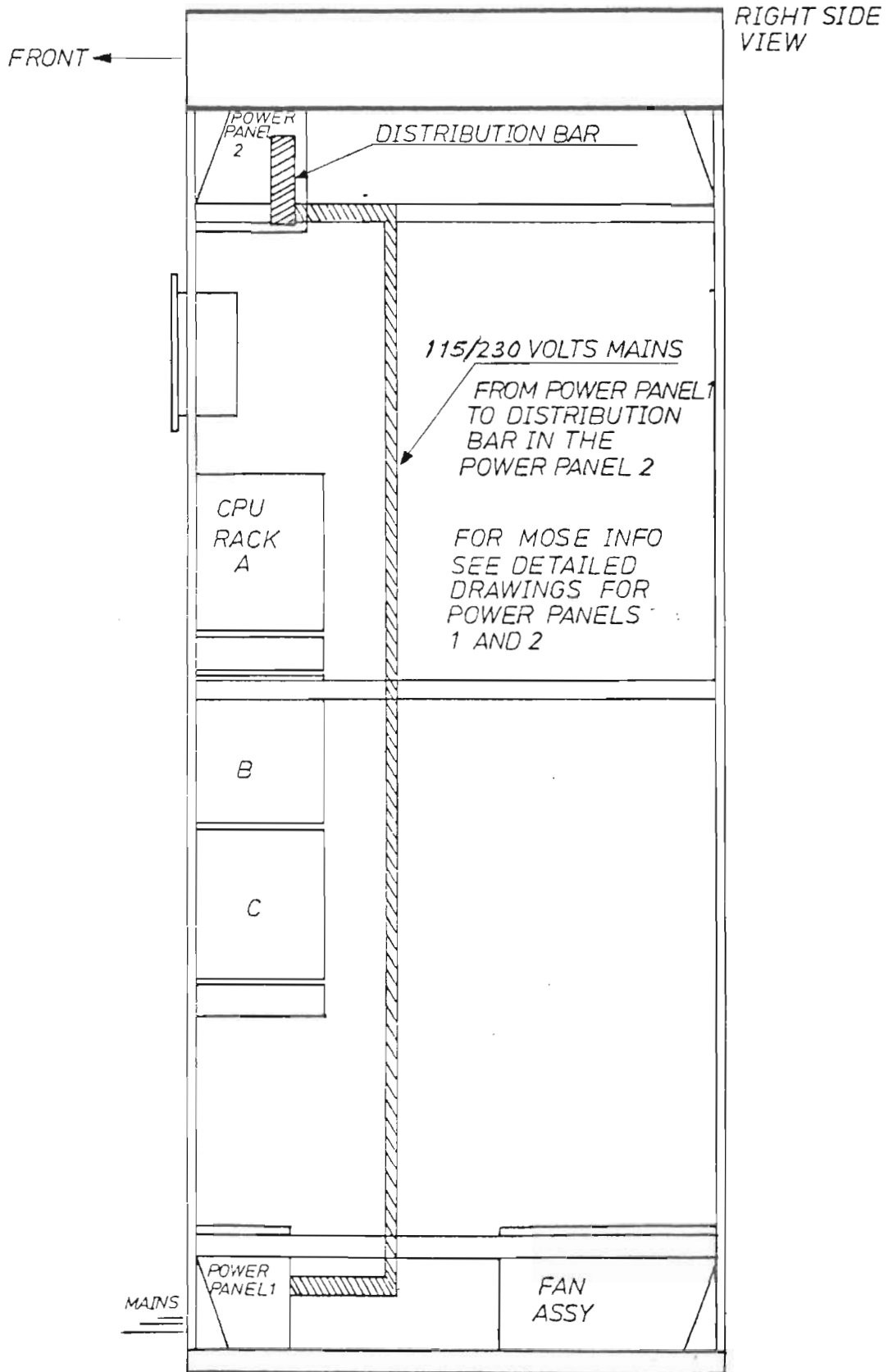

Figure 1.8: *NORD-10 115/230 Volts Mains Distribution*

ND - 30.001.01  
Rev A

1.4.4 *NORD-10 5V and 24V Distribution*

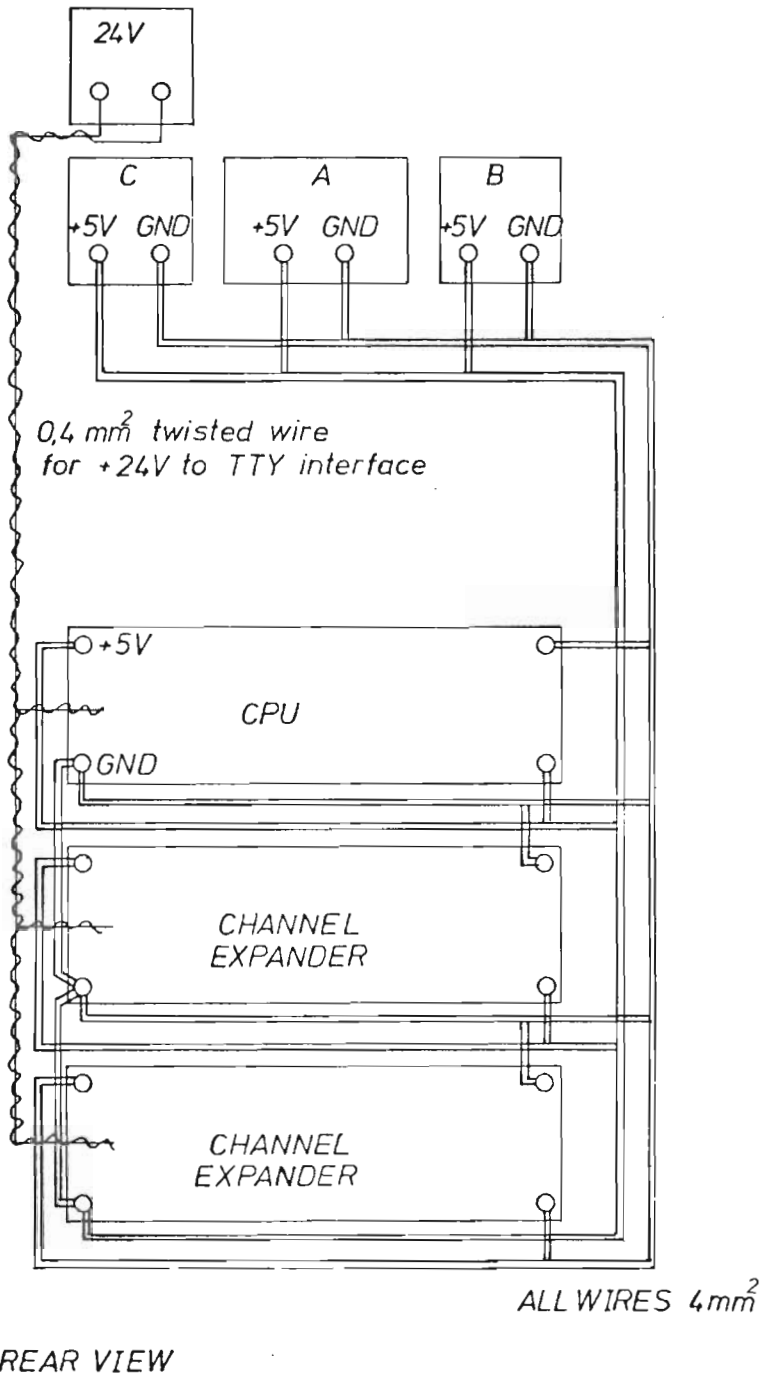

Figure 1.9: *NORD-10 5V AND 24V DISTRIBUTION*



1.4.5 *NORD-10 Fans Location and Air Flow*

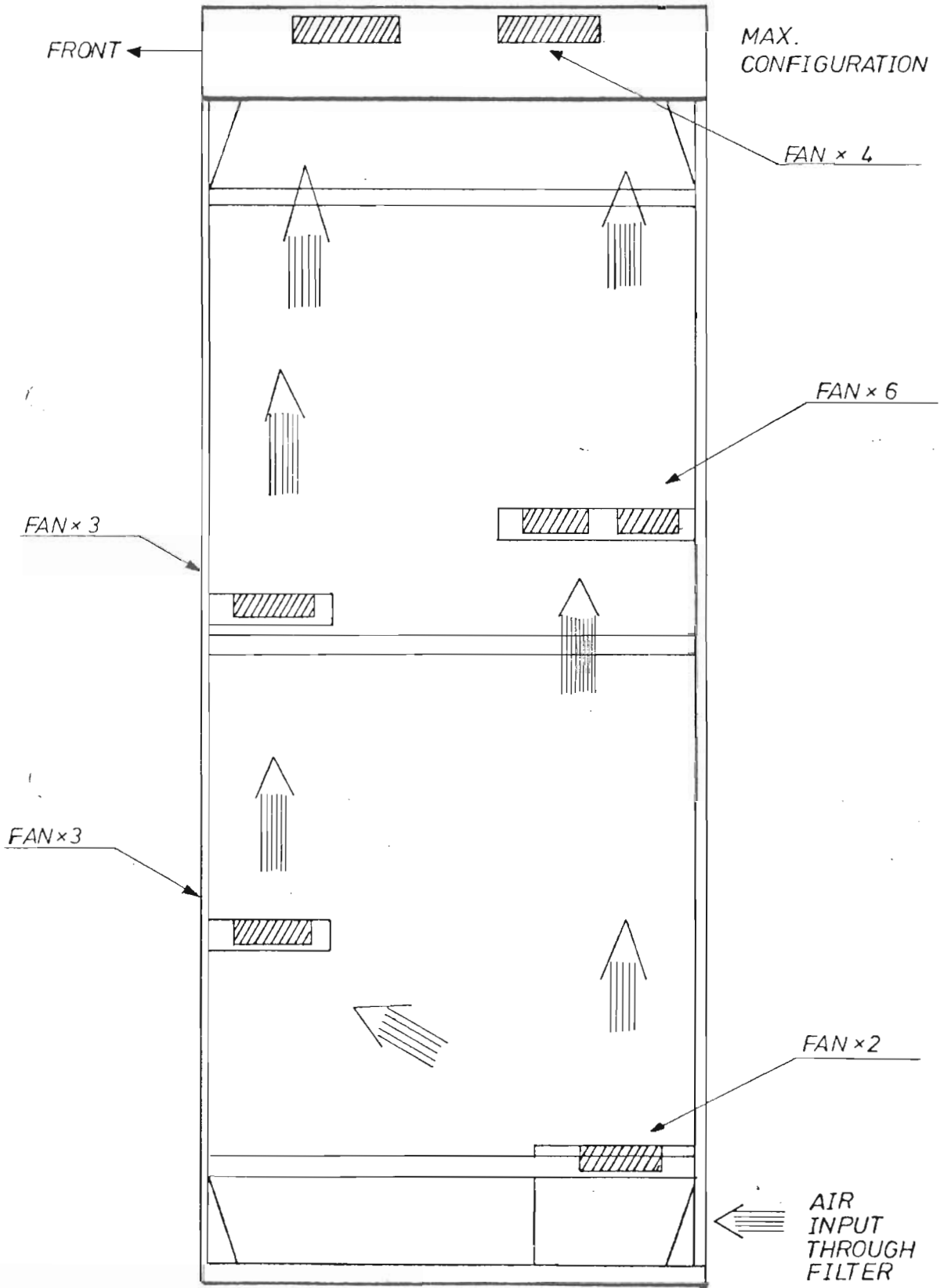

Figure 1.10: NORD-10 FANS LOCATION AND AIR FLOW

## 1.5 *NORD-10/S POWER UNIT*

### 1.5.1 *General*

The power system in NORD-10/S is divided into two parts:

1. 5V 150A switching supply used for CPU, I/O and memory control logic.
2. A serial regulated power supply giving:
  - \* +5V stand-by 8A
  - \* +12V stand-by 2A
  - \* -12V stand-by 70mA
  - +24 stand-by 6A
  - \* voltage applied to  
**MOS memory and  
Memory Refresh Logic**
  - \* in case of power failure the voltages will be present for 30 minutes supplied from two stand-by batteries (+5V and +12V). The +12V battery will also supply the -12V.
  - voltage may be used in I/O system for current loop interfaces.
  - up to  $\pm 10\%$  variation on mains input voltage is accepted.

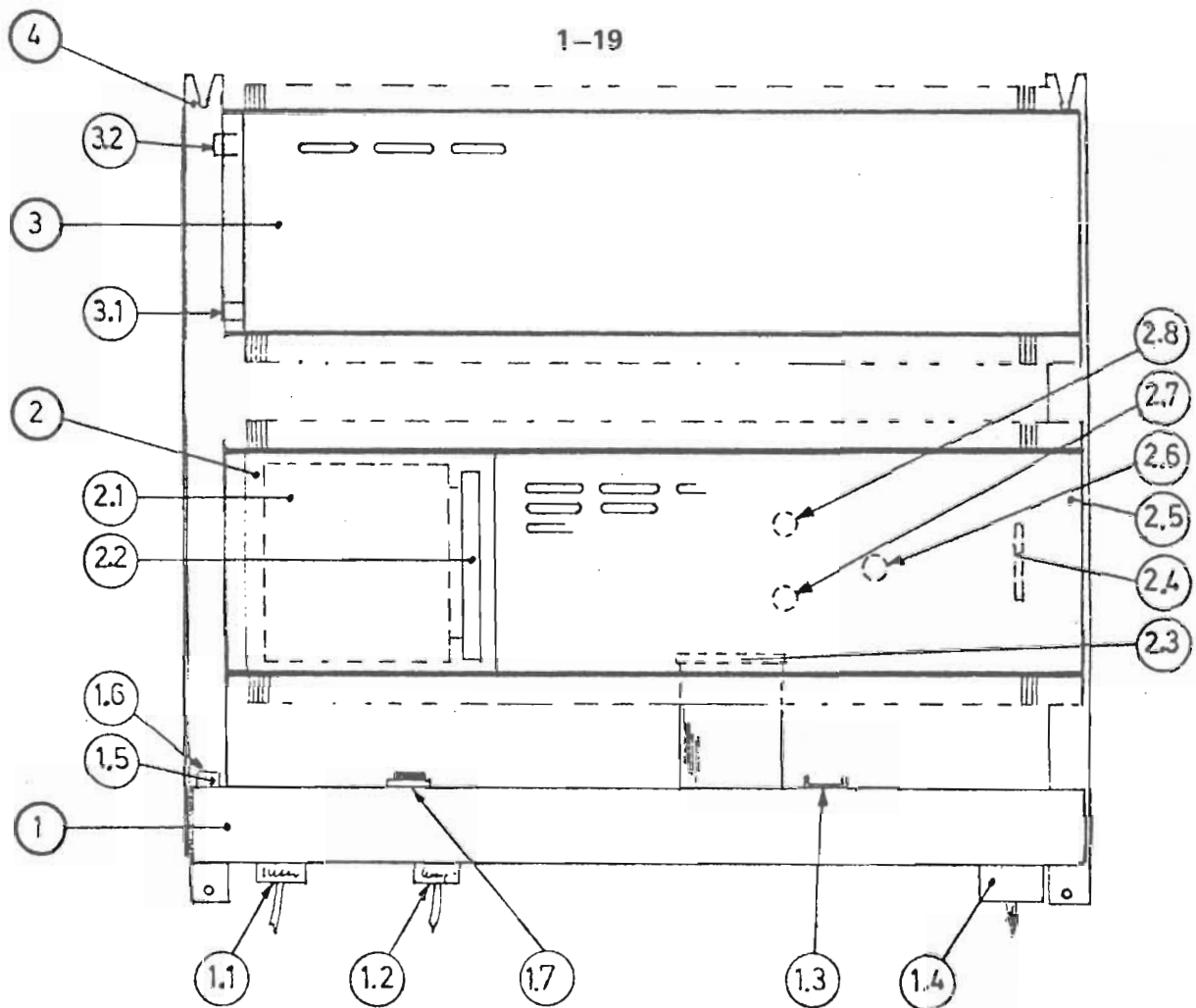

Figure 1.11: NORD POWER UNIT 10, MECHANICAL LAYOUT

- |     |      |  |
|-----|------|--|
| 1   |      | CONTROL PANEL                                  |
| 1.1 | PL.4 | Mains Plug                                     |
| 1.2 | PL.5 | Auxiliary output plug                          |
| 1.3 |      | Ambient temperature sence                      |
| 1.4 | PL.6 | Power output and control plug                  |
| 1.5 | PL.3 | Mains plug for mains transformer               |
| 1.6 | PL.2 | Mains plug for SMPS (Switch Mode Power Supply) |
| 1.7 |      | Alarm buzzer                                   |
| 2   |      | POWER UNIT                                     |
| 2.1 | T.2  | Mains transformer                              |
| 2.2 | PL.8 | Interconnection plug for mains transformer     |
| 2.3 | PL.1 | Interconnection plug for front panel           |
| 2.4 |      | Battery case                                   |
| 2.5 | P.9  | Current limit adjust 24V supply                |
| 2.6 | P.10 | Current limit adjust + 12V supply              |
| 2.7 | P.11 | Current limit adjust + 5V supply               |
| 2.8 |      |  |
| 3   |      | SWITCH MODE POWER SUPPLY                       |
| 3.1 | PL.7 | Interconnection plug for power unit            |
| 3.2 |      | Mains connection                               |
| 4   |      | MOUNTING FRAME                                 |

## 1.5.2 Control Panel Description

### 1.5.2.1 Indicators

<i>Label:</i>	<i>Location:</i>	<i>Description:</i>
+24V	1.1.1	Normally lit. Indicates presence of +24V.
-12V	1.1.2	Normally lit. Indicates presence of -12V.
+5V	1.1.3	Normally lit. Indicates presence of +5V.
Temp	1.1.4	Normally off. Temperature warning light lights when temperature reaches 55 <sup>o</sup> C.
Mains	1.1.5	Normally lit. Indicates presence of Mains (input voltage).
+5V	1.2.1	Normally lit. Indicates presence of +5V (150A) from switching P.S.
SB +12V	1.2.2	Normally lit. Indicates presence of +12V (stand-by).
SB +5V	1.2.3	Normally off. Indicates presence of +5V (stand-by).
0.V MAINS	1.2.4	Normally off. Overvoltage (mains) input.
Batt	1.2.5	Normally off. Indicates, when lit, that the voltages (+5V, +12V, -12V) are supplied by the batteries.
Power failure indicators:		
SB +5V	2.1	Indicators giving the source to the POWER FAILURE ALARM.
-5V	2.2	
SB +12V	2.3	
SB -12V	2.4	
+24V	2.5	1.14.

ALARM triggered when voltage < -5% and > + 10% of nominal voltage.

ALARM reset when toggling RESET switch (switch 3.1.14).

## 1.5.2.2 Switches

<i>Label:</i>	<i>Location:</i>	<i>Description:</i>
1-0	3.0	Normally 1. Connects/disconnects mains (input voltage).
H-N-L+5V	3.1	Normally in N position. When in H position increases the +5V (150A) with 5%. When in L position, decreases the +5V with 5%.  Note: For maintenance use only.
H-N-L+12V SB	3.2	Normally in N position. When in H position increases the +12V stand-by with 5%. When in L position, decreases the +12V stand-by with 5%.  Note: for maintenance use only.
H-N-L+5V SB	3.3	Normally in N position. When in H position, increases the +5V stand-by with 5%. When in L position, decreases the +5V stand-by with 5%.  Note: for maintenance use only.
H-N-L+24V	3.4	Normally in N position. $\pm 5\%$ marginal control.
Bat ON-OFF	3.5	Normally in ON position. Connects/disconnects the charge circuits for voltage back-up batteries.
ON	3.6	Reset over voltage alarm and indicators.

### 1.5.2.3 Adjustments

Note: Before performing the adjustments listed below, black plastic caps must be removed.

<i>Label:</i>	<i>Location:</i>	<i>Description:</i>
0.V	4.1	Adjustment of over voltage alarm.
Battery	4.2	Adjustment of batteries back-up level
Net	4.3	Power failures threshold adjustment. (Interrupt Level)
Temp	4.4	Adjustment of shot down level ambient temp.
-5V	4.5	Adjustment of -5V output.
+5V	4.6	Adjustment of +5V stand-by output.
+12V	4.7	Adjustment of +12V stand-by output.
+24V	4.8	Adjustment of +24V output.

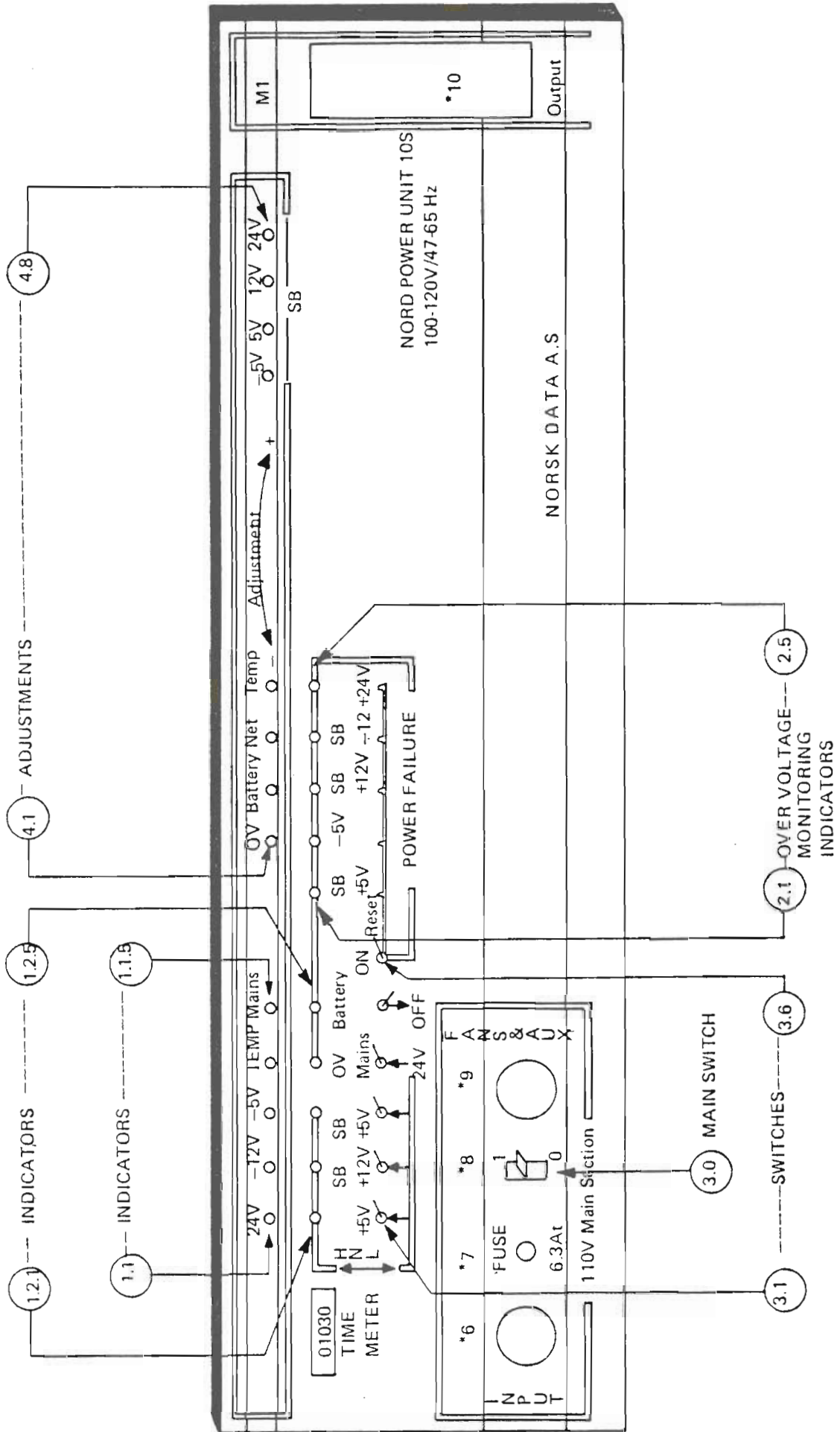

Figure 1.12: NORD POWER UNIT PANEL

### 1.5.3 *Power Fail/Automatic Restart*

#### *POWER FAIL*

The power fail unit is physically located in the power supply. The purpose of the power fail unit is to detect the presence of the input voltage 115/230 VAC and give an early warning to the CPU in case of power failure. This early warning is given through the internal interrupt system.

When notified that a power fail is in progress, the operating system will make the necessary steps towards a well defined stop point with the registers saved in memory. When the main power is restored, sensed by the power fail unit, the operating system will go through a restart procedure enabling the executing programs to resume.

Power interrupts will be given for the following reasons:

1. Mains voltage below preset limit
2. Ambient temperature exceeds preset limit
3. External temperature
4. Remote shut down of power

#### *AUTOMATIC RESTART*

When power again is restored, the capacitor is recharged above the sense level, and after a time delay of approximately 1 second, the OK signal is activated.

When the power clear signal disappears the CPU will enter STOP mode. The microprogram in STOP mode will read the operator's panel. If the operator's panel is locked this will generate a RESTART signal. The CPU is started in address 20 where the operating system's restart routines are located.



## 1.6 *PLUG PANEL*

The connections between the peripherals and the NORD-10/S goes via the plug panel. The plug panels are mounted at the bottom of the **NORD-10/S CPU** cabinet and in I/O cabinets (if available).

The plug panel is accessed from the rear of the cabinet(s).

This is depicted in the following:

1. The connection between the I/O rack and the plug panel.
2. Details of the I/O rack plug (BERG) and the plug panel plug (BURNDY).

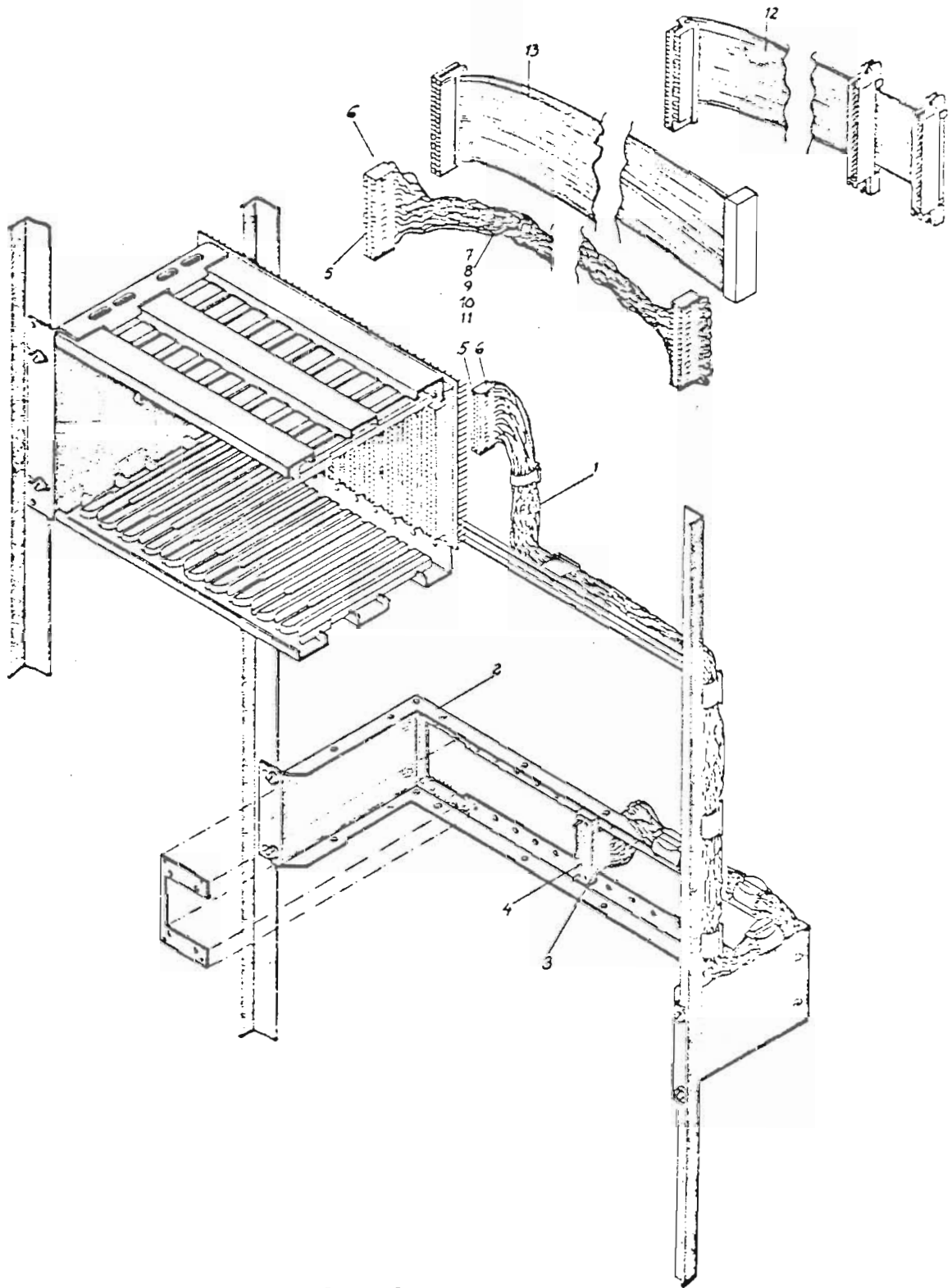

Figure 1.13: INTERNAL CABLES

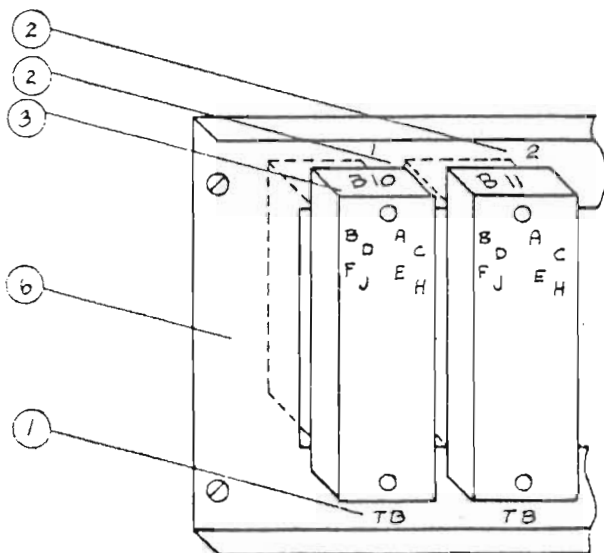
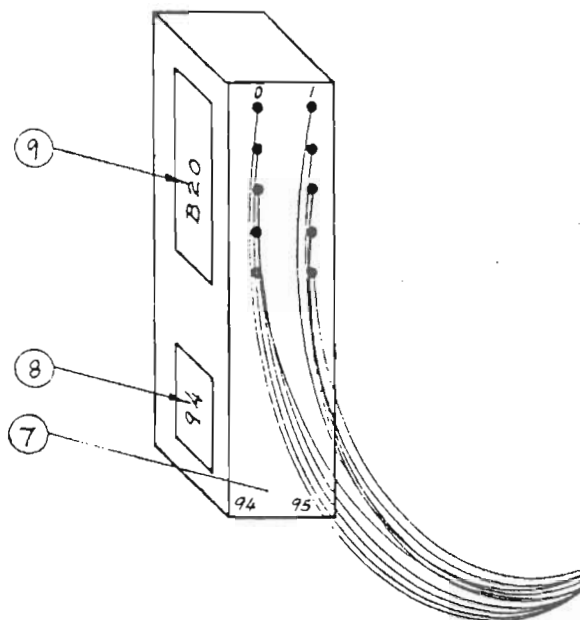

Figure I.14: PLUG PANEL DETAILS

- 1 Interface name
- 2 Interface number
- 3 Connected to rack and position
- 6 Plug panel for 42 pins BURNDY
- 7 BERG Plug
- 8 Pin number where BERG plug is to be inserted (bottom left corner)
- 9 Rack and position



## 2 OPERATING THE NORD-10/S

### 2.1 INTRODUCTION

The NORD-10/S CPU has two states or modes, STOP mode and CONTINUE mode. When the CPU is in STOP mode, the STOP light is on and the CPU is idle. In CONTINUE mode, the CPU is running and the CONTINUE light is on. It will continue running until it is stopped by either the operator pressing the STOP button, a program issuing a WAIT instruction (with the interrupt system off) or a serious error situation occurring.

When the CPU is running, the operator can only communicate with it through normal programs that can accept and handle input from some input device, usually the console terminal. However, when the CPU is in STOP mode, the NORD-10/S has a micro-program, a special program running in the hardware, for communication between the operator and the computer. This program, called MOPC (Microprogrammed Operators Communication), is in a special, high-speed, read-only memory and runs automatically when the machine is in STOP mode. MOPC may either be controlled from the console terminal (usually terminal number one) or from the operator's panel.

MOPC includes bootstrap programs and automatic hardware loads from both character oriented devices and mass storage devices. A bootstrap program is a program which runs in an otherwise empty computer and controls the loading and execution of another program.

This chapter tells how to communicate with MOPC using both the console terminal and the operator's panel. Many functions, such as memory examine and start a program can be carried out using either the console or the panel. The console is usually used for these functions because it is easier to handle. Other functions, such as master clear and power on, must be done with the panel buttons. Still other functions, such as bootstrap loading from a device other than the default device or running the micro-programmed memory test must be done from the console.

This chapter also gives a short description is given of how to start and stop the SINTRAN III operating system. This operating system is an interactive system where the users themselves control the system interactively through commands from user terminals. The functions of the operator are therefore generally restricted to starting and stopping the operating system and handling system error situations. In addition, there are supervisory functions such as loading the operating system, creating users, controlling mass storage space, etc. These are done by the system supervisors and are described in the SINTRAN III System Supervisor's Guide.

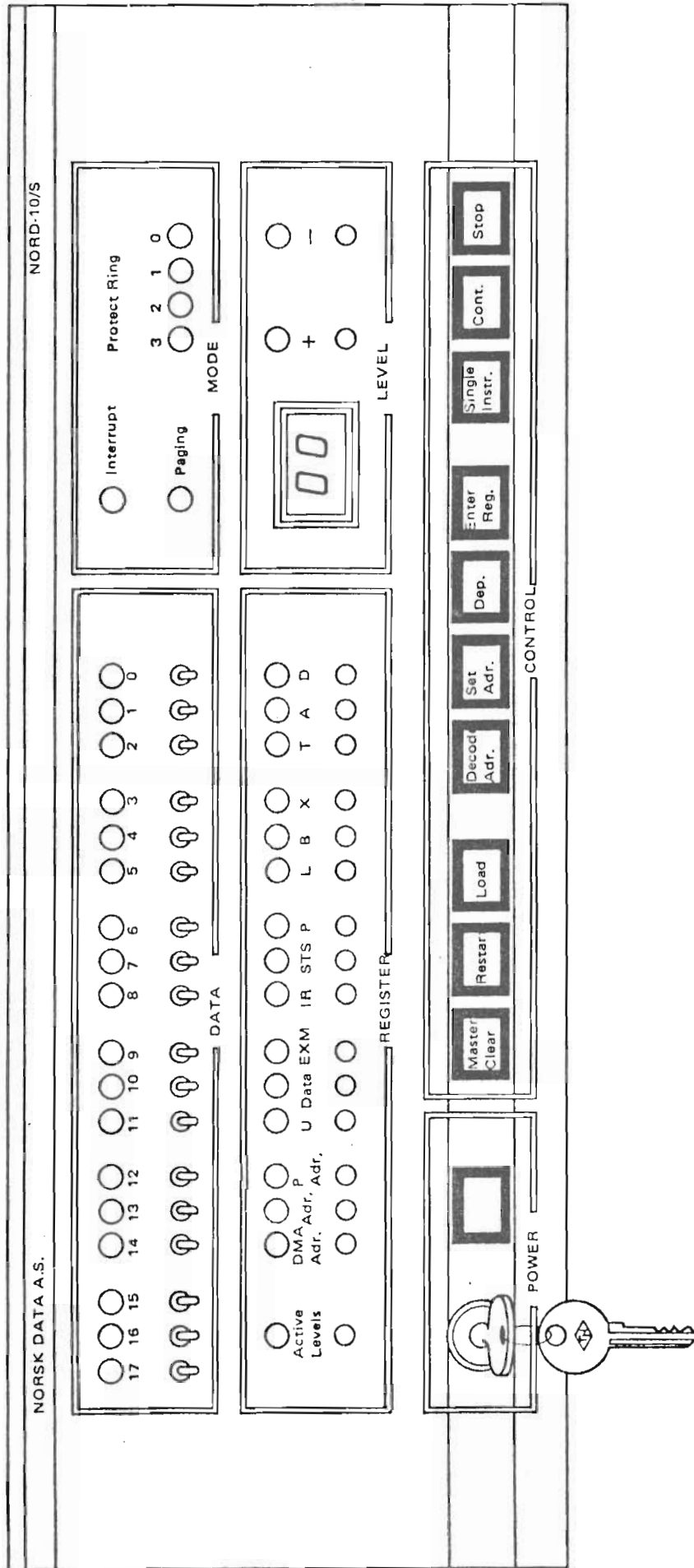

Figure 2.1: OPERATOR'S PANEL — PHYSICAL LAYOUT

## 2.2 THE OPERATOR'S PANEL

### 2.2.1 Panel Elements

The operator's panel for the NORD-10/S computer has the following elements:

1. An 18-bit switch register
2. An 18-bit light register
3. 16 selector push buttons and 16 associated lights
4. 6 mode indicators
5. A two-digit display and two push-buttons
6. 10 control buttons
7. Power on/off button
8. Panel key-lock

The operator's panel physical layout is depicted in Figure 2.1.

### 2.2.2 Power On/Off Button

Press for power supply.

#### *WARNING*

When the power is turned off on a NORD—10, the AC current is still available. To remove all current, the circuit breaker in the power panel in the bottom of the cabinet must be turned off. In the NORD—50, both AC and DC current are turned off immediately.

#### *NOTE*

All NORD—10s and NORD—50s in one computer complex must be turned on during operation (even if they are not all to be used).

### 2.2.3 Panel Key Lock

When the key switch is in the lock position, the 10 control buttons are disabled. In addition, the CPU is enabled for power failure restart.

When the key is in the unlock position, the control buttons may be used and the system will not be automatically restarted after power fail; the operator has to press the restart button.

## 2.2.4 Control Buttons

These 10 push-buttons are used to control the CPU and to modify registers and memory. The function of each of the buttons is given below.

### *Master Clear*

Generates a master clear signal to all hardware devices, turns off interrupt system, should only be used when the STOP light is on. Be aware that this signal will clear the old status of the computer. Do not press this button unless you are sure you want to do so.

Light in the MASTER CLEAR button indicates an error input to the CPU from operator's communication program or one of the load programs. The light is reset when the MASTER CLEAR button is pushed.

### *Restart*

This button generates a restart signal. When this signal is detected by the micro-program in STOP mode, the CPU will start in address 20. The RESTART button has no effect when the CPU is running. If the CPU is running, the STOP button must be pushed before the RESTART. To be sure that the program has been started on level zero, the MASTER CLEAR button should also be pushed.

### *Load*

Load from the device specified in the ALD register. Can be used only when the STOP light is on.

When a load program is active, the LOAD button lights up.

### *Decode Address*

This button is used in connection with the displaying of addresses (DMA ADR, ADR or P ADR selected). When this button is pushed, the address is not displayed directly. The address space is divided into 4K segments and each bit in the display register represents one segment. Bit 0 is lighted if address 0 - 777<sub>8</sub> is used, etc. Lighted keys indicate the state of the address display register.



*Set Address*

When the machine is in STOP mode and memory examine is desired, the address may be set up in the panel switch register and the SET ADDRESS button pushed. The address is now saved and it is not changed before the SET ADDRESS button is pushed again with a new content in the switch register. This address is also changed when a memory examine is executed from the console device (character "/" used).

Note that this button is used in STOP mode only. When the machine is running, the address in the switch register is used directly.

When the machine enters STOP mode, the register used by the set address function is set to zero. This means that after a single instruction the examined address is zero.

*Deposit*

When an address is selected with the SET ADDRESS button, the contents of this cell may be changed with the DEPOSIT button. The new contents are set up in the switch register and the DEPOSIT button pushed. The display selection must be EXM.

*Enter Register*

This button is used to load a register. One of the registers STS, P, L, B, X, T, A or D is selected with the register selection switches. Level is selected with the level selector. The contents of the switch register are now stored in the selected register when the ENTER REGISTER button is pushed.

*Single Instruction*

Pushing the SINGLE INSTRUCTION button causes a program to advance one instruction. The address is taken from the P register and the CPU goes back to STOP mode after execution of one instruction. The instruction is executed on the level given by the PIE and PID registers.

*Continue*

When this button is pressed, the machine starts running from the address specified by the P register. The level is given by the contents of PIE and PID registers. If the MASTER CLEAR is first pressed, PIE is cleared and the program is started on level 0.

If the light on the CONTINUE button is on, it indicates that the CPU is running.

*Stop*

Pushing this button stops the machine, i.e., the micro-program running in STOP mode is started. The STOP mode is indicated by light in the STOP button.

### 2.2.5 *Display Level Select*

The CPU has 16 program levels, each with its own set of registers. The level currently being used may be displayed and changed by means of the display level select. This consists of two push-buttons "+" and "-", and a two-digit display. By means of the two buttons, the level may be stepped up or down. The contents of the display show the selected level. If the display is stepped outside the limits 0-15, the two-digit display will show the active program level and the selected register (STS, P, L, B, T, A or D) is taken from the active level.

### 2.2.6 *Mode Indicators*

#### *INTERRUPT*

Indicates that the interrupt system is turned on, i.e. an ION instruction has been executed.

#### *PAGING*

Indicates that the paging system is turned on, i.e. a PON instruction has been executed.

#### *RING*

Four indicators show active program protect rings. These indicators are provided with after-glow so that it is possible to observe even the shortest execution run on each ring.

### 2.2.7 *18-Bit Switch Register*

This is used to present 16 bit data or 18 bit addresses to the CPU. Register contents, addresses and contents of memory locations may be displayed. The register 16 bits can be read from program with the TRA instruction.

### 2.2.8 18-Bit Light Register

This is used to display 16 bit addresses from the CPU. Register contents, addresses and contents of memory locations may be displayed. The register 16 bits can be set with the TRR LMP instruction (the user register must be selected).

### 2.2.9 16 Selector Push-Buttons and 16 Associated Lights

These push-buttons are used to select one of 16 possible registers to be displayed in the data display register. When one button is pushed (a register selected), this is indicated in the associated light above the button.

The possible register selections are as follows:

#### *ACTIVE LEVELS*

When this button is pushed, the data display (described above) will show the active program levels. 16 lights (0-15) are used, one for each of the 16 levels. In this mode the lamps are provided with after-glow so that it is possible to observe a single instruction on a program-level.

#### *DMA ADR*

If this button is pushed, the data display will show the active DMA (Direct Memory Access) address.

#### *ADR*

This register shows the current memory address being referenced, excluding DMA references and instruction (program) addresses.

#### *P ADR*

This is the memory address each time an instruction is read (fetch cycle). Effectively the data display will show the program address.

#### *U*

This is the user register set by the TRR LMP instruction.

*Note:* If the U register is set from a program by TRR LMP and the U is NOT selected, the setting of U will disturb the displaying of the selected register. The degree of disturbance will depend on the frequency of the U updating related to the panel interrupt frequency.

*DATA*

Displays data going to and from memory and on the I/O bus.

*EXM*

This selection has two uses:

**CPU in STOP**

The data display will show the contents of the memory location whose address is set in the switch register when the SET ADDRESS button was last pushed (see above). When the CPU stops, this address is preset to zero. (The selected address is always zero after pushing the SINGLE INSTR button.) Use of the '/' in MOPC will also set the memory address displayed.

**CPU running**

The data display will show the contents of the memory location whose address is set in the switch register. The memory location is sampled after each panel interrupt (about every 20 ms).

*IR*

This selection will display the CPU instruction register.

*STS, P, L, B, X, T, A, D*

If one of these is selected, the data display will show the contents of that register. The register is sampled at each panel interrupt. There is a complete set of these registers on each of the 16 program levels, so one has to select the appropriate level when one of these registers is examined.

## 2.3 THE CONSOLE TERMINAL

The console terminal communicates with the CPU through the MOPC program. When using it, the following characters are legal input characters:

0, 1, 2, 3,	
4, 5, 6, 7	Octal digits used to specify addresses and data
@	Restart MOPC, clear PIE (priority enable bit)
\$	Octal load
&	Binary load
!	(Exclamation point) Start program in main memory
/	Specifies register or memory cell to be examined
CR	(Carriage Return) Terminator of a line
LF	(Line Feed) Echoed, no other effect
	(Space) Any input before the space is ignored
B	Used to specify bank number
I	Specifies operation on an internal register
R	Specifies operation on one of the eight registers STS, D, P, B, L, A, T, X on a specified level
*	Current location counter for memory examine

Illegal characters are ignored. A "?" is displayed to indicate input error and the Master Clear button lights up.

A summary of the different functions of MOPC and some examples are given below. All addresses, physical device numbers and levels are octal and input from user is underlined in the examples.

### 2.3.1 *Functions*

#### *Start a Program*

Format:

<octal number> !

The machine is started in the address given by the octal number. If the octal number is omitted, the P register is used as start address, i.e. this is a "continue function". The program level will be the same as when the computer was stopped (if Master Clear has not been pushed or @ typed).

*Example:*

22 !            % start execution in location 22

#### *Memory Examine*

Format:

<octal number> /

The octal number before the character "/" specifies the memory address.

When the "/" is typed, the contents of the specified memory cell are printed out as an octal number.

If a CR (carriage return) is given, the contents of the next memory cell are printed out.

When the paging system is on, the bank number specifies which page table is used, and page faults and protect violations are ignored. In this case, <octal number> specifies a virtual address.

*Examples:*

<u>717</u> /003456	% EXAMINE ADDRESS 717
<u>717</u> /003456 (CR)	% EXAMINE ADDRESS 717
003450 (CR)	% EXAMINE ADDRESSES 720
000013	% AND 721

*Memory Deposit*

Format:

&lt;octal number&gt; (CR)

After a memory examine, the contents of the memory cell may be changed by typing an octal number terminated by CR.

*Example:*

```

717/003456 3475 (CR)  % THE CONTENTS OF ADDRESS 717
003450 1700 (CR)      % IS CHANGED FROM 3456 TO 3475
000123 (CR)           % AND 720 IS CHANGED FROM 3450
123456                % TO 1700. 721 CONTAINS 123 AND
                       % REMAINS UNCHANGED

```

*Register Examine*

Format:

&lt;octal number&gt; R &lt;octal number&gt; /

The first octal number specifies the program level (0-17). If this number is omitted, program level zero is assumed.

The second octal number specifies which register on that level to examine. The following codes apply:

- 0 Status register, bits 0-7
- 1 D register, double word extension of A register
- 2 P register, program counter
- 3 B register, base register
- 4 L register, link register
- 5 A register, main accumulator
- 6 T register, temporary help register
- 7 X register, index register

After the "/" is typed, the contents of the register is printed out.

*Examples:*

```

R5/   A register level 0
7R2/  P register level 7

```

*Register Deposit*

Format:

&lt;octal number&gt; (CR)

After a register examine, the contents of the register may be changed by typing an octal number terminated by CR.

*Examples:*

R5/ 123456 54321 (CR) % CONTENTS OF A REGISTER ON  
% LEVEL 0 IS CHANGED TO 054321

7R2/ 000044 55 (CR) % CONTENTS OF P REGISTER ON  
% LEVEL 7 IS CHANGED TO 000055



*Internal Register Examine*

Format:

I &lt;octal number&gt; /

The octal number specifies which internal register is examined. The following codes apply:

0	PANS	Operator's Panel Status, used by the operator's panel micro-program only.
1	STS	Status register, program level is contained in bits 8–11, bit 14 = PONI and bit 25 = IONI.
2	OPR	Operator's panel switch register.
3	PGS	Paging status register.
4	PVL	Previous program level.
5	IIC	Internal interrupt code.
6	PID	Priority interrupt detect.
7	PIE	Priority interrupt enable.
10	CSR	Cache status register, for maintenance only.
11	ACTL	Active level, decoded.
12	ALD	Automatic load descriptor.
13	PES	Memory error status.
14	MPC	Micro-program counter (will show a constant).
15	PEA	Memory error address.
16	IO	I/O transfer. Do not use.
17	—	Will show an arbitrary register. Do not use.

*Internal Register Deposit*

Format:

&lt;octal number&gt; /

After an internal register examine, the contents of the internal register with the same internal register code may be changed by typing an octal number terminated by CR. For deposit, the following internal register codes apply:

0	PANC	Operator's Panel Status, used by the operator's panel micro-program only.
1	STS	Status register, only bits 0-7 will be changed.
2	LMP	Operator's panel lamp register (will be overwritten unless U register is selected).
3	PCR	Paging control register.
4	MISC	"Miscellaneous" register (used by micro-program to control IONI, PONI, MCALL and MOPC).
5	IIE	Internal interrupt enable.
6	PID	Priority interrupt detect.
7	PIE	Priority interrupt enable.
10	CCLR	Cache Clear.
11	-	Not used.
12	CILR	Cache inhibit limits register.
13	CAR	Instruction register, used by micro-program subroutine only.
14	IR	Instruction register, used by the EXR instruction only.
15	ECCR	Error correction control register.
16	I/O	I/O transfer. Do not use.
17	-	Will change an arbitrary register. Do not use.

*Examples:*

```

17 / 030013 0 (CR)    % EXAMINE: PIE AND CHANGE TO
                               % 000000

12 / 021540 20044 (CR) % EXAMINE: ALD AND CHANGE
                               % CILR TO 020044 (ALD can only be set
                               % manually)

```

ND-30.001.01

*Current Location Counter*

When \* is typed, an octal number is printed indicating the current address on which a memory examine or memory deposit will take place. The current location counter is set by the memory examine command /, and it is also incremented for each time carriage return is typed.

*Break Function*

When @ is typed, the MOPC is restarted. This function is also used to terminate an octal load. PIE is set to zero.

*Bank Number*

Format:

<octal number> B

This command is used when the computer has more than 64K memory. The memory is divided into 64K banks (0-3).

This command has to be used to specify the bank number when a memory examine/deposit has to be done.

### 2.3.2 *Bootstrap Loaders*

The NORD-10/S has bootstrap loaders for both mass storage and character oriented devices. Three different load formats are standard:

- Octal format load
- Binary format load
- Mass storage load

#### *Octal Format Load*

Octal load is (normally) started by typing:

<physical device address> \$

The operator's communication will start taking its input from the device with the specified device address. The device must conform with the programming specification of either teletype or tape reader. The device address is the lowest address associated with the device.

During octal load there is no echoing of characters. All legal operator commands are accepted. Illegal commands terminate the loading and "?" is typed on the console. (In installations without a console an attention lamp is turned on.) Normally, @ or ! is used to terminate an octal load.

If no device address precedes the \$ command, the \$ is nearly equivalent to pushing the LOAD button on the operator's panel.

#### *Binary Format Load*

Binary load is (normally) started by typing:

<physical device address> &

Loading will take place from the specified device. This device must conform with the programming specifications of either teletype or tape reader. The device address is the lowest address associated with the device.

If no device address precedes the & command, then the & is nearly equivalent to pushing the LOAD button on the operator's panel.

If a checksum error is detected, "?" is typed on the console (in installations without a console an attention lamp is turned on) and control is returned to the operator's communication.

**Note** that the binary loader does not require any of the main memory.

The binary load will change the registers on level 0.

The binary load format is compatible with the format dumped by the )BPUN command in the MAC assembler. (See the NORD-10/S Reference manual under binary load for a description of the binary load format.)

#### *Mass Storage Load*

When loading from mass storage, 1K words will be read from mass storage address 0 into main memory starting in address 0. After a successful load, the CPU is started in main memory address 0.

If an error occurs, the loading is terminated and "?" is typed on the console and control is returned to the operator's communication. (Note: in installations without a console, an attention lamp is turned on.)

The actual mass storage must conform with either drum or disk programming specifications.

Mass storage load must be started by typing \$ or &, or pushing the LOAD button on the operator's panel. However, this requires a special setting of the ALD.

#### *Automatic Load Descriptor (ALD)*

The NORD-10/S has a 16-bit switch register called Automatic Load Descriptor (ALD). This register is located on the panel driver card and can only be set by manually setting the switches on the card. This register specifies the load procedure to use when the LOAD button is pushed or when a single \$ or & is typed.

The load procedure will indicate which device to load from, the type of load (octal, binary, or mass storage), whether a real load is needed or just a restart, or if a special diagnostic program is to be started.

The format of the ALD register is as follows:

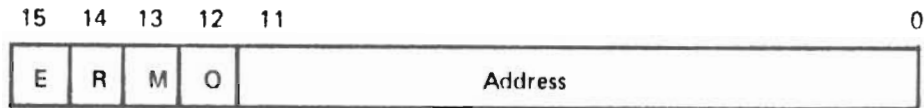

Automatic Load Descriptor (ALD) Format:

**E Extensions**

If this bit (bit 15) is 1, then the load function is extended. Effectively, the micro-program jumps to the micro address found in ALD, bits 0-11.

(The E bit is used when starting micro-programmed diagnostic programs. The start address is put in ALD bits 0-11.)

**R Restart**

If this bit (bit 14) is 1, the load function degenerates to a jump to main memory address:

$$\text{Address} = 4 * (\text{ALD bits 0-13})$$

This bit is used when the bootstrap program is held in read only main memory. (Note: E = 0.)

This restart must not be confused with the RESTART button on the operator's panel.

**M Mass Storage Load**

If this bit (bit 13) is 1, mass storage load is taken from the device whose (lowest) address is found in ALD bits 0-10 (unit 0). (Note: E = R = 0.)

**O Octal Format Load**

If this bit (bit 12) is set, octal format load will take place from the device whose (lowest) address is found in ALD bits 0-10.

If bit 12 is not set, binary format load will take place from the device whose (lowest) address is found in ALD bits 0-10.

Note:  $\$$  will override this bit, a single  $\$$  will start an octal format load from the device whose (lowest) address is found in ALD bits 0-10. (Note: E = R = M = O.)

**Address**

The hardware device address of the device to be loaded from.

Following is a table showing possible use of the ALD setting.

Command	<n> \$	\$	<n> &	&	Pushing LOAD
ALD					
000300	Octal load from <n>	Octal load from 300	Binary load from <n>	Binary load from 300	Binary load from 300
014400	Octal load from <n>	Octal load from 400	Binary load from <n>	Octal load from 400	Octal load from 400
020540	Octal load from <n>	Mass storage load from 540	Binary load from <n>	Mass storage load from 540	Mass storage load from 540
077760	Octal load from <n>	Start in address 177700	Binary load from <n>	Start in address 177700	Start in address 177700
103000	Jump to $\mu$ address 3000	Jump to $\mu$ address 3000	Jump to $\mu$ address 3000	Jump to $\mu$ address 3000	Jump to $\mu$ address 3000

Table 2.1: ALD SETTING

## 2.4 STARTING AND STOPPING A NORD-10/S

A short description of the procedure for starting and stopping the NORD-10/S and the SINTRAN III operating system is given here. The procedure assumes that SINTRAN has been correctly installed, all initial actions have been carried out, and it is just necessary to start it up. For all information needed to do these tasks, see the SINTRAN III System Supervisor's Guide. See that manual also for details of how to carry out such functions as updating the clock and entering main directory (referred to below).

### 2.4.1 Starting Up Procedure

- Switch on the computer

Press the POWER (if the power is off) and MASTER CLEAR buttons

- Start the disk(s)

Switch on the two or three switches at the back of the disk unit(s)

Press the START button on the disk panel.

When the READY lamp lights up, the disk is ready to be accessed.

- Turn on the console terminal

Depress the power button (make sure it has the correct speed and that the local/line switch is set to line)

- Load SINTRAN III

Assuming the ALD register is correct, press MASTER CLEAR and LOAD.

- When the CONTINUE button lights up and SINTRAN III IS RUNNING is printed on the console do one of the following:

- a) If system initialization is completely automatic, nothing needs to be done except to update the clock (after logging in).

(ESC)  
HH.MM.SS DAY MONTH YEAR

press escape button to activate terminal  
the date plus installation defined text is  
printed out (0 after LOAD)

ENTER SYSTEM  
PASSWORD secret: word

type your user name (SYSTEM)  
type the password (not seen)

OK  
@UPDATE: mm hh dd mm yy

update the clock  
terminate the session

@LOGOUT  
HH.MM.SS DAY MONTH YEAR

- EXIT -



- b) If system initialization is not completely automatic, the main directory has to be entered and other relevant commands given. A MODE file should exist for giving them. See SINTRAN III System Supervisor's Guide for a description of these commands.

Log in as above. Give the following commands:

@ENTER-DIRECTORY main—directory—name, device—name, unit,  
F or R or blank

@MODE input-file, output-file

@UPDATE mm hh dd mm yyyy

Log out as above,

- Put the operator's panel key in lock position.
- Switch on other terminals and the different peripherals

## 2.4.2 *When To Stop a NORD-10/S Installation*

It is advisable to let the NORD-10/S run day and night. The disks and printers, however, should usually be turned off if the system is to be idle for more than a couple of hours (nights, weekends, holidays).

If the entire installation is shut off, it is important that the disks are switched off before the NORD-10/S.

### STOP PROCEDURE

- Prevent users from logging in:  
@SET-SINTRAN-UNAVAILABLE
- Wait until all users are logged off (a broadcast message may be sent asking them to log off).
- Turn off devices with mechanical movement (disks, printers).
- Turn off the NORD-10/S only in special cases - in general the NORD-10/S should not be turned off.



### 3 PREVENTATIVE MAINTENANCE AND ERROR HANDLING

#### 3.1 PREVENTATIVE MAINTENANCE

This section is divided into two parts, one for the owner, and one for the ND Service Department.

For more information on part two, contact the ND Service Department.

##### 3.1.1 *Maintenance To Be Done By The Owner*

###### *Level 0 (Daily).*

- 1 Site should be kept clean and dustfree.  
*Note:* Never turn the computer power off during nights, weekends etc.  
Do not perform any kind of operation inside the computer without permission from the ND Service Department.

###### *Level 3 (Monthly).*

- 1 Clean air filters in running water. If there is a metal filter, use a vacuum cleaner.

### 3.1.2 *Maintenance To Be Done By The ND Service Department*

#### *Level 4 (Quarterly).*

- 1 Observe that all fans work properly.
- 2 Clean air filters in running water. If there is a metal filter, use a vacuum cleaner.
- 3 Check power supply output.
- 4 Update ECO level. Remember documentation.
- 5 Check all push buttons and lamps on operator panel.
- 6 Start and test operating system.

#### *Level 6 (Annually).*

- 1 Perform lower level maintenance.
- 2 Clean the computer. If necessary clean the boards, gold-contacts and memory-modules with "Isopropanol" and vacuum-cleaner.
- 3 Check power-supply output.

## 3.2 SYSTEM FAILURES

This chapter contains general information about system failures, how they are detected and how they may be corrected.

Error procedures are given for situations where the computer stops (the STOP light is on), hangs (the STOP light is not on, but the computer does not respond) or is completely dead (no lights are on). These procedures are given as diagrams of questions and actions depending on the answers. A procedure is also given for restarting SINTRAN after a system failure. Since error situations are usually detected through error messages from SINTRAN III, these messages are listed, together with suggested operator actions for the different messages.

A chapter in the System Supervisor's Guide contains more detailed information about system failures and the operator is referred to that manual if the information here is not sufficient.

System failures are considered to include all types of errors and irregularities that cause the system to go down or run with lowered performance. Whenever a system failure occurs, it is the system supervisor's responsibility to take control of the installation. He/she should identify the type of system failure, get all the necessary information to describe the state of the computer, and try to get the installation working again.

System failures may be of two types:

- nonfatal errors
- fatal errors

NONFATAL ERRORS are detected by SINTRAN III, and an error message will appear on the user's terminal or on the error message terminal (usually the console terminal).

Only error messages from the SINTRAN III monitor will be looked at in this section. These will probably be the most useful from the system supervisor's point of view, since some of them may indicate errors in the hardware or in the SINTRAN III operating system.

The different error messages and some additional information about each of them can be found in Section 3.4.

FATAL ERRORS will almost all be detected by SINTRAN III, but no error message will be given. The system will go into a "stop" condition or will "hang up". Information about what should be done before contacting ND can be found in the flow diagram.

3.3 ERROR PROCEDURES FOR FATAL ERRORS

3.3.1 Computer "Hanging" Procedure

Procedure for dumping registers and memory when computer is in STOP or all/most terminals are hanging.

NO	Is the computer "dead" i.e. no lamps alight?	YES	
NO	Is the computer in STOP mode?	YES	Follow instructions on next page for DEAD computer
	Note the active levels		
	Press STOP		
	Note the active level		
NO	Is console terminal in correct status? (i.e. speed setting, line/local, paper, etc.)	YES	
	Fix it		
NO	Is there any response from the hardware operator communication on the console terminal?	YES	
Press MASTER CLEAR	Type: 11/ 13/ 14/ 15/ 16/ 17/ 111/ 113/ 115/		
	NO Is bit 6 of 113 set (=1)?	YES	
Any response now?	Type: 16R2/ 16R3/ 16R4/		Call ND
NO YES	Find the value of ERRFATAL from PART1 listing. (ERRFA) It should be around 161		
Call ND	NO Is the value of 16R2 equal to ERRFATAL	YES	
	Subtract 200 <sub>g</sub> from the value of 16R3. Dump the value of this location and the next 4 locations E.g. 16R3 = 5641 5441/12450 % PGRR 3 % ACTIVE 3 % IBITNO 0 % PESERR 0 % PEAERR		
	YES PESERR = 0?	NO	
	NO Were all/most terminals hanging?	YES	Call ND
	Find the file system stack pointer 70717/ ... FSTCK NO 70006 < FSTCK < 70717? YES		
	Dump the locations from 70000 to FSTCK 70000/ ... ↓ ... ↓		
	Press MASTER CLEAR		
	Type: R0/ R1/ R2/ R3/ R4/ R5/ R6/ R7/		
	Insert MEMTOF floppy in floppy unit 0. Type: 1560&		
	Remove MEMTOF and insert a new formatted floppy. Type: any character on the console terminal		
	When FINISHED DUMP is typed on the console, remove the floppy and label it		
	Goto restart procedure		
	You should now contact ND		

### 3.3.2 Computer "Dead" Procedure

The following flow diagram describes action to be taken if the computer appears completely "dead", i.e. the A/C line current is absent.

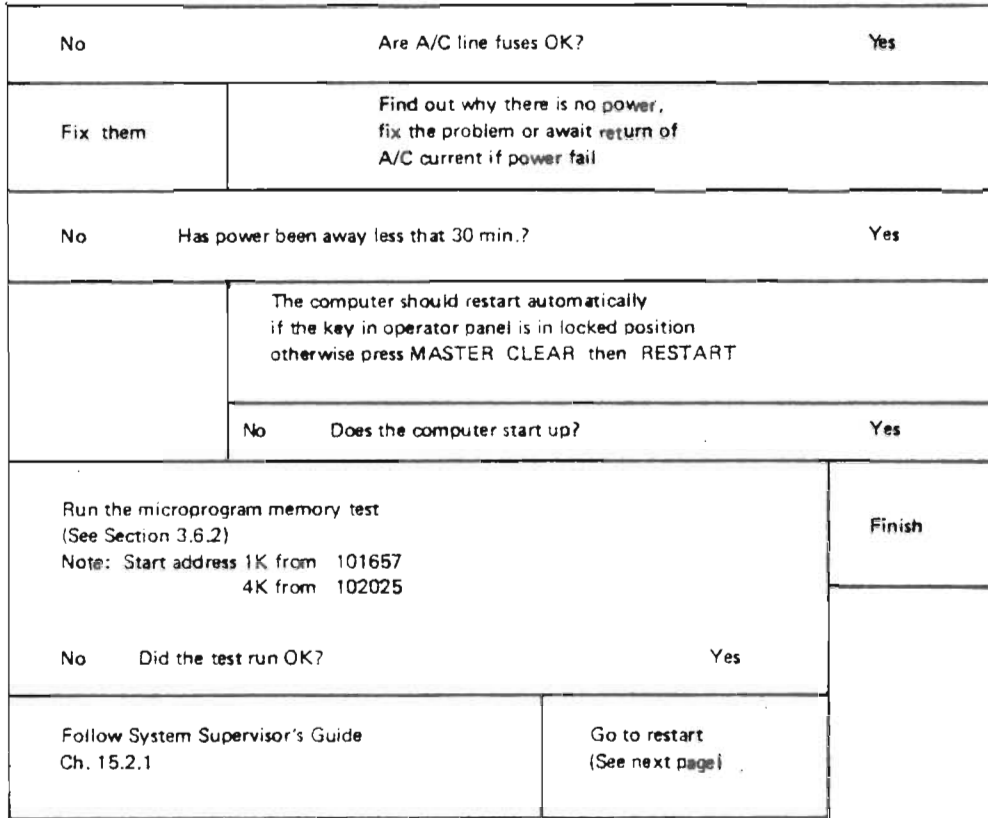

**WARNING**

Some computers have an alarm which indicates an error in the power supply. If the alarm goes off (a high whine), stop the system and contact ND.

3.3.3 Start/Restart Procedure

The following flow diagram describes the action to taken to restart a computer running SINTRAN III.

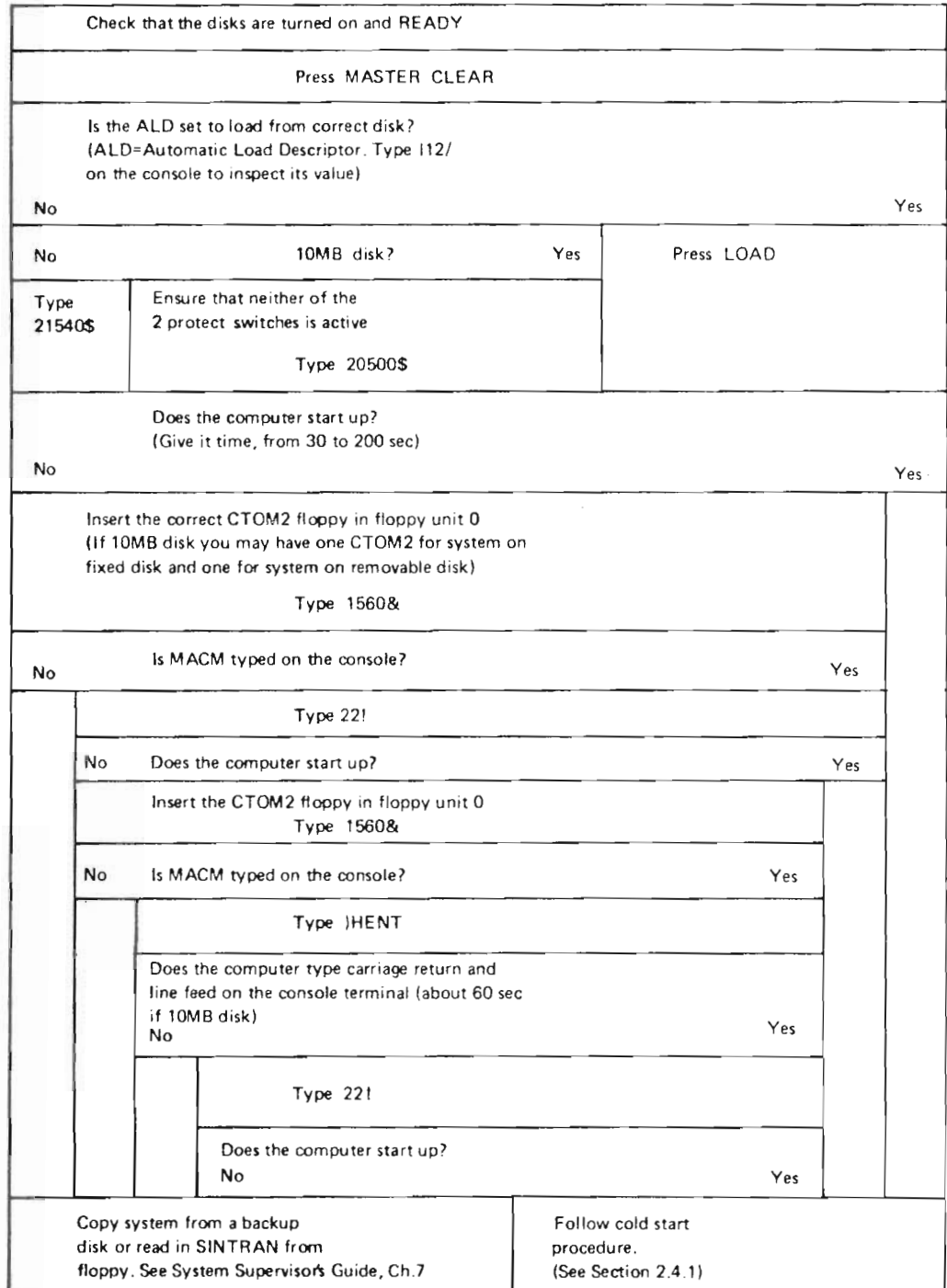



## 3.4 *ERROR MESSAGES FROM SINTRAN III MONITOR*

### 3.4.1 *Error Message Format*

At run-time, errors may be detected by the system. Most of the errors will cause the current program to be aborted and the error message:

```
aa.bb.cc. ERROR nn IN rr AT ll; tttt
xx yy
```

will be printed.

If the error occurs in a background program, the error message will be written on the corresponding terminal. For programs, the error message will come to the error message terminal (usually terminal 1).

The parameters have the following meaning:

aa.bb.cc	Time when the error message was printed. aa hours bb minutes cc seconds
nn	Error number. For further explanation, refer to the list on the following page.
rr	Octal address corresponding to program name, or the program name itself.
ll	Octal address where the error occurred.
tttt	Explanatory text.
xx, yy	Numbers carrying additional information about the error. One or both numbers can be omitted.

*Example:*

```
01.43.32 ERROR 14 IN BAKD3 AT 114721;
OUTSIDE SEGMENT BOUNDS
```

In case of a transfer error, an additional message TRANSF will be given. This special message is described later in this section under special error message.

### 3.4.2 Error Number Summary

Run-time error codes are listed here. For a more detailed description and suggested operator action, see the next section.

<i>Error Code</i>	<i>Meaning</i>	<i>xx</i>	<i>yy</i>	<i>Program Aborted</i>
00	Illegal monitor call			yes
01	Bad RT program address			yes
02	Wrong priority in PRIOR			yes
03	Bad memory page	page no.		
04	Internal interrupt on direct task level	level	bit	no
06	Batch input error	error no.		yes
07	Batch output error	error no.		yes
08	Batch system error	error no.	L register	yes
09	Illegal parameter in CLOCK			yes
10	Illegal parameter in ABSET			yes
11	Illegal parameter in UPDAT			yes
12	Illegal time parameters			yes
13	Page fault for non-demand			yes
14	Outside segment bounds			yes
15	Illegal segment number	segment no.		yes
16	Segment not loaded	segment no.		yes
17	Fixing demand	segment no.		yes
18	Too many fixed pages	segment no.		yes
19	Too big segment	segment no.		yes
20	Disk/drum transfer error	Hardware device no.	unit	no (aborted if segment transfer)

<i>Error Code</i>	<i>Meaning</i>	<i>xx</i>	<i>yy</i>	<i>Program Aborted</i>
21	Disk/drum transfer error	disk address	hardware status	See explanation
22	False interrupt	level		no
23	Device error	hardware device no.	hardware status	no
25	Already fixed	segment no.		yes
26	Mass storage time-out			no
27	Illegal parameter in CONCT			yes
28	Space not available	segment no.		yes
29	MON 64 and MON 65	error no.	error message	no (MON64) yes (MON65)
30	Divide by zero			yes
31	Permit violation			yes
32	Ring violation			yes
33	Illegal instruction			yes
34	Illegal instruction			yes
35	RT FORTRAN stack error			yes
36	Privileged instruction			yes
37	IOX error	Address	Level	no
38	Memory Parity	PEA register	PES register	yes
39	Memory out of range	PEA register	PES register	yes
40	Power fail			no
41	Illegal error in EIRMON			yes
42	Overlapping segments	segments		yes
44	Corrected memory error	PEA register	PES register	no

<i>Error Code</i>	<i>Meaning</i>	<i>xx</i>	<i>yy</i>	<i>Program Aborted</i>
45	Not demand segment			yes
90	FORTTRAN run-time error	error no.		no
91	FORTTRAN I/O error	error no.		no
100	FTN library error			

### 3.4.3 System Actions and Operator Responses

The run-time errors explained in detail

#### 00 ILL. MONITOR CALL

*Explanation:* A monitor call (MON instruction) is used in a wrong way or an incorrect argument is used in a MON instruction. Probable user error.

*System action:* The specified RT program is aborted.

*Operator's response:* If system RT program, list RT description of RT program and call Norsk Data for software support. If user RT program, report the error to the user.

#### 01 ILL. RT-PROG

*Explanation:* An incorrect address of the RT description. Probable software error.

*System action:* See error code 00.

*Operator's response:* See error code 00.

#### 02 ILL. PRIORITY

*Explanation:* An incorrect priority used in the monitor call PRIOR. The priority should be a number between 0 and 255. Probable software error.

*System action:* See error code 00.

*Operator's response:* See error code 00.

#### 04 INTERNAL INTERRUPT ON DIRECT TASK LEVEL LEVEL NO BIT NO

*Explanation:* An internal interrupt from direct task level. Probably user error.

*System action:* Priority is given up.

## 06 BATCH INPUT ERROR

FILE ERROR NO.:

File system error description

*Explanation:* The batch supervisor has not found the input file for the current batch job. The user probably has forgotten to include USER-NAME as a part of the batch input file name.

*Operator's response:* Report the error to the owner of the batch job.

## 07 BATCH OUTPUT ERROR

FILE ERROR NO.:

File system error description

*Explanation:* An output error has occurred in a batch job running in batch mode. The file system error description explains the error. As for 06 but for the output file.

*Operator's response:* Report the error to the owner of the batch job.

## 08 BATCH SYSTEM ERROR

FILE ERROR NO.:

ADDRESS

*Explanation:* An error has occurred in the batch system. Probable software system error.

*Operator's response:* Check if the batch system is properly initialized. If it is, report the error to Norsk Data for software support.

## 09 ILL. PARAM. IN CLOCK

*Explanation:* Incorrect array address used as argument in the monitor call CLOCK. User error.

*System action:* See error code 00.

*Operator's response:* See error code 00.

## 10 ILL. PARAM. IN ABSET

*Explanation:* Incorrect parameter(s) used in the monitor call ABSET.  
User error.

*System action:* See error code 00.

*Operator's response:* See error code 00.

## 11 ILL. PARAM. IN UPDAT

*Explanation:* Incorrect parameter(s) used in the monitor call UPDAT.  
User error.

*System action:* See error code 00.

*Operator's response:* See error code 00.

## 12 ILL. TIME PARAM.

*Explanation:* Incorrect parameter(s) used in the monitor call TIME.  
Probable user error.

*System action:* See error code 00.

*Operator's response:* See error code 00.

## 13 PAGE FAULT FOR NON-DEMAND

*Explanation:* An RT program on a non-demand type segment tried to use an address outside the segment bounds. Probable user error.

*System action:* See error code 00.

*Operator's response:* See error code 00.

*Example:*

09.53.10 ERROR 13 IN 23/33 AT 6157; PAGE FAULT FOR NON-DEMAND

## 14 OUTSIDE SEGMENT BOUNDS

*Explanation:* An RT program on a demand type segment tried to use an address outside the segment bounds. Probable user error.

*System action:* See error code 00.

*Operator's response:* See error code 00.

## 15 ILL. SEGMENT NUMBER

## SEGMENT NO.

*Explanation:* Overlap of the address area or incorrect segment number(s) used as parameters in the monitor call MCALL or MEXIT. Probable user error.

*System action:* See error code 00.

*Operator's response:* See error code 00.

## 16 SEGMENT NOT LOADED

## SEGMENT NO.

*Explanation:* The segment in FIX/UNFIX is a demand segment or the segment is not loaded by the RT loader. Probable user error.

*System action:* See error code 00.

*Operator's response:* See error code 00.

## 17 FIXING/DEMAND

## SEGMENT NO.

*Explanation:* Trying to fix a demand segment.

*System action:* See error code 00.

*Operator's response:* See error code 00.

## 18 TOO MANY FIXED PAGES

## SEGMENT NO.

*Explanation:* Trying to fix more pages than allowed. Only a limited amount of physical memory may be used for fixed segments at a time.

*System action:* See error code 00.

*Operator's response:* See error code 00.



## 19 TOO BIG SEGMENT

*Explanation:* A non-demand type segment is bigger than the SINTRAN swapping area. Probable user error.

*System action:* See error code 00.

*Operator's response:* See error code 00.

## 20 DISK/DRUM TRANSFER ERROR

HARDWARE DEVICE NO.

UNIT

## 21 DISK/DRUM TRANSFER ERROR

DISK-ADDRESS

STATUS

*Explanation:* These two error messages will always appear together and indicate a mass storage transfer error. Hardware error.

Some device numbers:

500	CDC disk system 1
510	CDC disk system 2
540	Drum system 2
550	Drum system 2
1540	Big disk system 1
1550	Big disk system 2

The status word gives the type of error(s) (refer to the "NORD-10/S Reference Manual").

*System action:* If segment transport, the specified RT routine is aborted. No system action if error return from a monitor call (RFILE/WFILE).

*Operator's response:* If address mismatch (status is xxx4xx) or parity error (status is xx1xxx) occurred, test the disk for parity errors. If the error recurs, use the function REFRESH (tracks will be reformatted and information restored if possible) and call Norsk Data for hardware support.

## 22 FALSE INTERRUPT

## LEVEL (DEC)

*Explanation:* Level 10, 11, 12 or 13 is activated but the IDENT instruction does not find a correct ident code. Possible noise or hardware error.

*Level:*

- 10 output interrupt
- 11 mass storage interrupt
- 12 input interrupt
- 13 real-time clock

*Operator's response:* Run Configuration Investigator to check the state of the different device interfaces. Call hardware support if necessary.

## 23 DEVICE ERROR

## HARDWARE DEVICE NO.

## STATUS

*Explanation:* A device failure has occurred, probably hardware error.

The following device numbers are used:

100- 157	Synchronous modem buffer card
200- 277	Asynchronous modem buffer card, terminal buffer card
1200-1277	Asynchronous modem buffer card, terminal buffer card
300- 377	Teletype buffer card, terminal buffer card
1300-1377	Teletype buffer card, terminal buffer card
400- 477	Paper tape devices, line printers, etc.
500- 577	Mass storage devices
1500-1577	Mass storage devices

The status word gives a more precise description of the error. See the status word description for the specified device.

*Operator's response:* Report the error to Norsk Data and call for hardware support. Run test program for the failing device.

25 ALREADY FIXED

SEGMENT NO

*Explanation:* Trying to refix a segment.

*System action:* See error code 00.

*Operator's response:* See error code 00.

26 MASS STORAGE TIME-OUT

*Explanation:* If the disk does not respond within a certain time interval (4 seconds) this message is printed.

*Operator's response:* Call for hardware support only if the error recurs several times.

27 ILL. PARAM. IN CONCT

*Explanation:* Incorrect parameters used in the monitor call CONNECT. Probable user error.

*System action:* See error code 00.

*Operator's response:* See error code 00.

28 SPACE NOT AVAILABLE

SEGMENT NO.

*Explanation:* Trying to load more information on a segment than possible.

*System action:* See error code 00.

*Operator's response:* See error code 00.

## 29 FILE SYSTEM ERROR

## FILE ERROR NO.

## File system error description

*Explanation:* The monitor call **ERMSG** (64) or **QERMS** (65) is used to write a file system error message. A parameter will hold the error code. These commands are normally used to write error messages in case of error exits from file system commands.

*System action:* **ERMSG** will give no system action, **QERMS** will abort the specified RT routine.

*Operator's response:* See error code 00.

## 30 DIVIDE BY ZERO

*Explanation:* Division of a floating point number with zero fraction is attempted.

*System action:* See error code 00.

*Operator's response:* See error code 00.

## 31 PERMIT VIOLATION

*Explanation:* The RT program attempted to access a page with an illegal reference type. Probable user error.

Each individual segment may be protected against:

- read access
- write access
- instructions fetch access

*System action:* See error code 00.

*Operator's response:* See error code 00.

## 32 RING VIOLATION

*Explanation:* The RT program attempted to execute an instruction or access data on another page with higher ring status. Probable user error. See "NORD-10/S Reference Manual".

*System action:* See error code 00.

*Operator's response:* See error code 00.

## 34 ILL. INSTR.

*Explanation:* The RT program attempted to execute an instruction not implemented. Probable user error.

*System action:* See error code 00.

*Operator's response:* See error code 00.

## 35 RT-FTN STACK ERROR

*Explanation:* An RT FORTRAN program attempted to use the stack outside the stack bounds.

*Operator's response:* Report the error to the user of the FORTRAN job. He/she will probably have to increase the stack size of his/her program.

## 36 PRIV. INSTR.

*Explanation:* An RT program attempted to execute a privileged instruction. See the "NCRD-10/S Reference Manual".

*System action:* See error code 00.

*Operator's response:* See error code 00.

## 37 IOX ERROR

ADDRESS

LEVEL (DEC.)

*Explanation:* This could mean either no answer from external device or an IDENT instruction is executed without an interrupt waiting. Probable hardware error.

*System action:* Run Configuration Investigator to check the state of the different device's interfaces. Call for hardware support only if the error recurs several times.

## 38 MEMORY PARITY

PEA  
PES

*Explanation:* A memory parity error has occurred. Probable hardware error. The bad memory page could be taken out of use by a patch. PEA gives the memory error address and PES gives the memory error status and bank number. See the "NORD-10/S Reference Manual".

*Operator's response:* Take the bad page out of use and restart SINTRAN. Report the error to Norsk Data and call for hardware support. To take out the bad page:

- take the six most significant bits of the error address to find the failing page
- see the software system report (SSR) SIN-313 for further assistance

## 39 MEMORY OUT OF RANGE

PEA  
PES

*Explanation:* An attempt to address a non-existent memory location has occurred. Probable hardware or system software error. PEA and PES as for error code 38.

*Operator's response:* Report the error to Norsk Data and call for hardware support.

## 40 POWER FAIL

*Explanation:* This message will be given when SINTRAN automatically restarts after a power failure or STOP-SYSTEM command.

*Example:*

```
14.21.32 EFIRDR40 IN 23327 AT 110330: POWER FAIL

17.13.29 ERROR 37; IOX ERROR
ADDRESS: 5747; LEVEL(DEC.): 12

17.13.32 ERROR 22 AT 16; FALSE INTERRUPT
LEVEL(DEC.): 12
```

## 41 ILL. ERROR IN ERMON

*Explanation:* Trying to use an error number outside the specified interval for ERMON.

*System action:* See error code 00.

*Operator's response:* See error code 00.

## 42 OVERLAPPING SEGMENTS

## SEGMENTS

*Explanation:* The two segments used by an RT program overlap in the virtual address space.

*System action:* See error code 00.

*Operator's response:* See error code 00.

## 44 CORRECTED MEMORY ERROR

PEA  
PES

*Explanation:* An error has occurred in memory and is corrected.

*System action:* The error is corrected.

## 90 FORTRAN RUN-TIME ERROR

ERROR NO.

*Explanation:* A run-time error has occurred in a background FORTRAN job.

*Operator's response:* Report the error to the owner of the FORTRAN job.

## 91 FORTRAN I/O ERROR

ERROR NO.

*Explanation:* An input error has occurred in a background FORTRAN job. The file system error description, explains the error. User software error.

*Operator's response:* Report the error to the owner of the FORTRAN job.

**SPECIAL ERROR MESSAGE****TRANSF!!**

This message is printed out when a transfer error occurs during a paging operation on the disk. Because the error message routine is resident on a segment, and the error has occurred when transferring a page to/from a segment, the simple message TRANSF!! is stored in memory and written out by a special routine which is also resident in memory.

*System action:* RT program is aborted. Background program returns to command mode.

*Operator's response:* Error is due to either a disk error (hardware) or a memory error. Run DIMS, BIMS or GREMS to check the disk for parity errors. Run MULTI to test the memory.



### 3.5 ERROR MESSAGES FROM SINTRAN III FILE SYSTEM

*Error Code:    Meaning:*

000	Not used
001	Not used
002	Bad file number
003	End of file
004	Card reader error (card read)
005	Device not reserved
006	Not used
007	Card reader error (card not read)
010	Not used
011	Not used
012	End of device (time-out)
013	Not used
014	Not used
015	Not used
016	Not used
017	Not used
020	Not used
021	Illegal character in parameter
022	No such page
023	Not decimal number
024	Not octal number
025	You are not authorized to do this
026	Directory not entered
027	Ambiguous directory name
030	No such device name
031	Ambiguous device name
032	Directory entered
033	No such logical unit
034	Unit occupied
035	Master block transfer error
036	Bit file transfer error
037	No more tracks available
040	Directory not on specified unit
041	Files opened on this directory
042	Main directory not last one released
043	No main directory
044	Too long parameter
045	Ambiguous user name
046	No such user name
047	No such user name in main directory
050	Attempt to create too many users
051	User already exists
052	User has files
053	User is entered
054	Not so much space unreserved in directory
055	Reserved space already used

*Error Code:    Meaning:*

056	No such file name
057	Ambiguous file name
060	Wrong password
061	User already entered
062	No user entered
063	Friend already exists
064	No such friend
065	Attempt to create too many friends
066	Attempt to create yourself as friend
067	Continuous space not available
070	Not directory access
071	Space not available to expand file
072	Space already allocated
073	No space in default directories
074	No such file version
075	No more pages available for this user
076	File already exists
077	Attempt to create too many files
100	Outside device limits
101	No previous version
102	File not continuous
103	File type already defined
104	No such access code
105	File already opened
106	Not write access
107	Attempt to open too many files
110	Not write and append access
111	Not read access
112	Not read, write and common access
113	Not read and write access
114	Not read and common access
115	File reserved by another user
116	File already opened for write by you
117	No such user index
120	Not append access
121	Attempt to open too many mass storage files
122	Attempt to open too many files
123	Not opened for sequential write
124	Not opened for sequential read
125	Not opened for random write
126	Not opened for random read
127	File number out of range
130	File number already used
131	No more buffer space
132	No file opened with this number
133	Not mass storage file
134	File used for write
135	File used for read
136	File only opened for sequential read or write

<i>Error Code:</i>	<i>Meaning:</i>
137	No scratch file opened
140	File not reserved by you
141	Transfer error
142	File already reserved
143	No such block
144	Source and destination equal
145	Illegal on tape device
146	End of tape
147	Device unit reserved for special use
150	Not random access on tape files
151	Not last file on tape
152	Not tape device
153	Illegal address reference in monitor call
154	Source empty
155	File already opened by another user
156	File already opened for write by another user
157	Missing parameter
160	Two pages must be left unreserved
161	No answer from remote computer
162	Device cannot be reserved
163	Overflow in read
164	DMA error
165	Bad data block
166	CONTROL/MODUS word error
167	Parity error
170	LRC error
171	Device error (read-last-status to get status)
172	No device buffer available
173	Illegal mass storage unit number
174	Illegal parameter
175	Write-protect violation
176	Error detected by read after write
177	No EOF mark found
200	Cassette not in position
201	Illegal function code
202	Time-out (no data block found)
203	Paper fault
204	Device not ready
205	Device already reserved
206	Not peripheral file
207	No such queue entry
210	Not so much space left
211	No spooling for this device
212	No such queue
213	Queue empty
214	Queue full
215	Not last used by you
216	No such channel name
217	No remote connection

*Error Code:    Meaning:*

220	Illegal channel
221	Channel already reserved on remote computer
222	No remote file processor
223	Formatting error
224	Incompatible device sizes
225	Remote processor not available
226	Tape format error
227	Block count error
230	Volume not on specified unit
231	Not deleted record
232	Device error
233	Error in object entry
234	Odd number of bytes (right byte in last word insignificant)
235	Error in backspace/forward space print
236	Block format error
237	Overflow in write

### 3.6 *TEST AND UTILITY PROGRAMS*

There exists a range of test and verification programs for testing memory, CPU, mass storage and I/O devices. Most of these programs are described in the manual (several volumes):

- Test Program Descriptions

An information sheet describing the purpose of the tests, their names and the loading/operating procedures follows each program. In addition, a chapter in the System Supervisor's guide contains information about the test and utility programs available and some information on their use.

### 3.6.1 Test Program Summary

In this chapter we have listed the most used programs, divided into different types.

- 1 CPU
- 2 MEMORY
- 3 INPUT/OUTPUT
- 4 MASS STORAGE
- 5 UTILITY PROGRAMS FOR DISK/MAGTAPE

#### NOTE

The list of test programs will change quite often. For an up-to-date list, see the latest version of the Test Program Description Manuals.

#### CPU TEST PROGRAMS

<i>Program Name</i>	<i>Purpose</i>
ONE-CHECK-1192	Instruction check
TWO-CHECK-1190	Instruction check
THREE-CH-1528	Instruction check
FOUR-CH-1418	Instruction check
EXTEN-ONE-1519	Instruction check, all level's
RGCHK-1543	Register
CACHE-2063	Cache
PAGING	Paging
TREAL-1399	Real-Time clock
FLOATING-1529	48 bit floating
T-32B-FLOA-1860	32 bit floating
PFAIL-1355	Power fail restart

#### MEMORY TEST PROGRAMS

MULTI-1820	Memory
MEMORY	8K MOS modules
T32KMOS-2178	32K MOS modules
ERRCOR-2112	Error correction (memory)
MPM-MAINT-2177	Big multiport memory log
MOVER-1863	Memory

*TEST PROGRAMS FOR INPUT/OUTPUT DEVICES*

TERMINAL - ASYNC	Terminals
TNCT-2039	Nord colour terminal
FLOPPY-FU-1986	Floppy disk
TESTMONO-1534	NORDCOM
TLINE-1541	Synchronous modem
CARDR-1642	Card reader
TERMBUF-1751	Terminal interface ND 253
FLOPPY-RAN-1988	Floppy Disk
CHATA-1832	Asynchronous inter computer link
CONFI INV-1672	Configuration Investigation
LP-TEST-1878	Line Printers
PARAL-BYTE-1942	Parallel Byte interface
FLOP- FROM-1990	Diskette formatting
INTER - T -2233	External interrupts
MEM - TEST-2304	DMA to memory
PROCES - PAN-1865	Check process panel
TET2200	Test TDV-2200
TREPU-1269	Tape reader and punch
VERSATEST-2297	Versatec printer/plotter

*TEST PROGRAMS FOR MASS STORAGE*

DISC -TEMA	Test and utility program for all disks
SUPER-RAND-2222	To test the controller and 38/75/288Mb disks. Writes on disks.
ECCTEST-2224	Error correction facility test for 38/75/288Mb controller. Doesn't write on disks.
BIG-RAND-1876	Random data and address test for 33/66Mb disks. Writes on disks.
DSERV 1395	Adjustment program for cartridge disks.
TECOD 1451	Test of cartidge disks and controller.
TANB-MAG-1559	Test program for Pertec/Tandberg Magnetic tape stations.
DIMS	Utility program for cartridge disks
DS1172-2282	Universal DMA interface S1172
HPMAG-1523	HP magnetic tape
PASCAN-2226	Pack verification 75/288 Mb
SMALL-RAND-2448	Random test on 10 Mb disk
STC -RUNNER-2410	STC magtape subsystem
STC-TEST-2411	STC magtape controller
TCODR-1299	Core and drum
TSTAD-1870	Check big disk addresses

*UTILITY PROGRAMS FOR MASS STORAGE*

COP-VERIFY-2035	To copy between disks, drums and floppies. Disks: cartridge,33/66/, 38/75/288Mb.
MCOPY-TANDB-1649	Copy program for backup of cartridge and 33/66Mb disks on Pertec/Tandberg Mag
FILSYS-INV-2135	To check and investigate the content of a directory on disks (all disks).

A cross-reference between test programs and the hardware that they test is given in Appendix D.



### 3.6.2 *Memory Test by Using the Microprogram*

For each NORD computer there is a memory test program located in the ROM (read only memory) to quickly test the memory. This is a very useful feature as it may quickly be decided whether a given error is to be blamed on the CPU or the memory. To use the test program do the following:

- Press STOP and MASTER CLEAR
- Give lower memory address, R3/ (usually 0)
- Give upper memory address, R7/ (32K = 077777, 64K = 177777)
- start the test program by typing "start address"\$

```
memory bank 0 = 101657$
memory bank 1 = 1B101657$
memory bank 2 = 2B101657$
memory bank 3 = 3B101657$
```

As long as it runs, the load button will light up. If errors occur, the MASTER CLEAR button will light up and a question mark will be printed on the console.

The following registers in level 0 give information about the error:

```
P register:  R2/ (address of location with error)
L register:  R4/ (correct bit pattern)
D register:  R1/ (wrong bit pattern)
T register:  R6/ (error bit(s))
```

Note: For the 4K microprogram the start address of the memory test is 102025. To test the memory in various banks, type:

```
102025$ for memory bank 0 (0-64K)
1B102025$ for memory bank 1 (64-128K)
2B102025$ for memory bank 2 (128-192K)
3B102025$ for memory bank 3 (192-256K)
```



## 4 THE NORD-50 COMPUTER SYSTEM

### 4.1 INTRODUCTION

The NORD-50 Computer System is a completely integrated system of the NORD-10/S and the NORD-50 CPUs. The I/O system, file system and operating system are common to both processors

The NORD-50 CPU is designed to be a fast floating point processor which is a total slave to the NORD-10/S.

NORD-50 does not have an I/O system or interrupt system by itself. This implies that NORD-10/S submits jobs to NORD-50 for execution in batch and acts as a system supervisor running the operating system SINTRAN III/VS and the NORD-50 monitor.

In a NORD-50 computer system, the NORD-10/S has the following functions:

- Supervision and synchronization of the NORD-50s in the system.
- Running the operating system, SINTRAN III.
- Generating NORD-50 executable machine code via NORD-50 assembler or FORTRAN compiler.
- Being the I/O system for the NORD-50s performing I/O transfer to/from the NORD-50 memory.

The NORD-50s in the system perform execution of instructions with data supplied through the NORD-10/S I/O system from byte oriented devices such as terminals, general DMA devices such as disks and magnetic tapes, the universal DMA interface, and special high-speed DMA channels connected directly to ports in the multiport memory system.

The system architecture is such that NORD-50s can have their private memories including a high speed static memory in addition to the multiport memory system.

The NORD-50s themselves do not perform any tasks except for running the application programs.

The slave-processor NORD-50 is activated by the NORD-10/S and the NORD-50 executes programs in parallel with the activities in NORD-10/S. The NORD-10/S is interrupted when the NORD-50 comes to an end of its tasks.

The architecture of the standard NORD-50 computer system is suitable for real-time applications needing large computational capacity because:

- It has real-time and high volume computational system architecture in one integrated system.
- Concurrent execution of large CPU bound jobs may take place on the NORD-50 together with real-time and time-sharing activities on the NORD-10/S.
- The NORD-50 has a large address space of 4M bytes.

Some other important attributes of the NORD-50 CPU are as follows:

- 32 bit word length.
- Physical addressing range of 4M bytes (20 address bits).
- High data precision - 23 or 55 bit mantissa and 9 bit exponent plus a sign bit.
- Extensive instruction set with single and double precision floating point instructions.
- Multiported shared and private memory.
- Static high speed, private memory for frequently used code and data.
- Instruction look-ahead for increased performance.
- Specialized arithmetic unit for floating multiply/divide and integer multiply/divide.
- Specialized arithmetic unit for shift, bit operations and floating add/subtract.
- 2 identical blocks of 64 registers, each 32 bits, to obtain increased speed in register operations.

### 4.1.1 Specifications and Performance Characteristics

#### PROCESSOR

32 bit parallel processor, 64 bit parallel arithmetic during floating operation.

#### TYPICAL INSTRUCTION EXECUTION TIMES

Instruction Type	Single precision ( $\mu$ s)	Double precision ( $\mu$ s)
LOAD REGISTER	1.5	2.4
STORE REGISTER	1.6	2.3
ADD — memory to register	1.5	NA
FLOATING ADD — memory to register	1.8	2.5
REGISTER ADD — register to register	0.7	NA
FLOATING REGISTER ADD	0.8	0.8
MULTIPLY — register by memory	5.7	NA
FLOATING REGISTER MULTIPLY	3.7	7.1
FLOATING MULTIPLY	4.7	8.7
DIVIDE — register by memory	2.5-5.7	NA
FLOATING DIVIDE — register by memory	4.7	8.7
FLOATING REGISTER DIVIDE	3.7	7.1

All execution times include pre- and/or post indexing.

#### MEMORY

Maximum physical memory address space:	512 K words (32 bits)
Access time for Static Memory:	250 ns
Cycle time for Static Memory:	350 ns
Access time for Multiport Memory:	435 ns
Cycle time for Multiport Memory:	450 ns
Parity (static memory):	2 bits — one per byte
Error Checking and Correcting Memory:	21 bits, single bit detection and correction (40% of all double bit errors detected)
Battery stand by power for memory:	Maximum 15 minutes



## ELECTRICAL AND PHYSICAL SPECIFICATIONS (NORD-50 CABINET)

Power consumption .....1000W

## Power requirements:

ND 1400 .....220VAC  $\pm$  10%, 50Hz  $\pm$  2HzND 2400 .....110VAC  $\pm$  10%, 60Hz  $\pm$  2Hz

Operating temperature..... + 10° C to + 35° C

Operating relative humidity .....10% to 90% non condensing

## Physical dimensions:

Width..... 59,5 cm

Height.....160 cm

Depth..... 60,5 cm

Volume ..... 0.576 m<sup>3</sup>

Weight.....100 kg

## 4.2 *NORD-50 COMPUTER SYSTEM ARCHITECTURE*

### 4.2.1 *Basic Configuration*

The basic NORD-50 system always relies on the NORD-10/S as the system supervisor. The NORD-10/S runs the operating system, file system, editor, compilers, loader etc. and the NORD-50 monitor. The monitor acts as an interface between NORD-50 programs and the operating system, giving services to NORD-50 programs.

The NORD-10/S and the NORD-50 directly share the I/O system by having a common DMA channel for accessing block oriented devices such as the disk. The NORD-10/S with SINTRAN III/VS controls the I/O system but does not as such participate in the physical transfers.

Both processors have private memory and may also share the same memory together with the DMA channel.

To control the NORD-50, the NORD-10/S has a NORD-10/S—NORD-50 communication interface for starting and stopping the NORD-50. In addition, different control and status information is passed between the processors, such as specified break for overflow, underflow, divide by zero, memory protect error, etc. The communication interface also supports a memory examine/deposit function such that the NORD-10/S may reach all of NORD-50 memory even if this memory is larger than the normal maximum NORD-10/S addressable memory of 512K bytes. See figure 4.1.

### 4.2.2 *Multiple NORD-50 Configurations*

The internal architecture of the NORD-50 computer system allows two or more NORD-50s to be configured into the same system. The NORD-10/S will be the system supervisor and control all NORD-50s and supply them all with operating system services.

The NORD-50s and the NORD-10/S may be configured in many ways, allowing:

- all peripherals to be shared (without bus switching)
- all processors to have private memory
- all or just some to access shared memory
- two or more NORD-50s to have a memory to memory communication, thus reducing shared memory contention



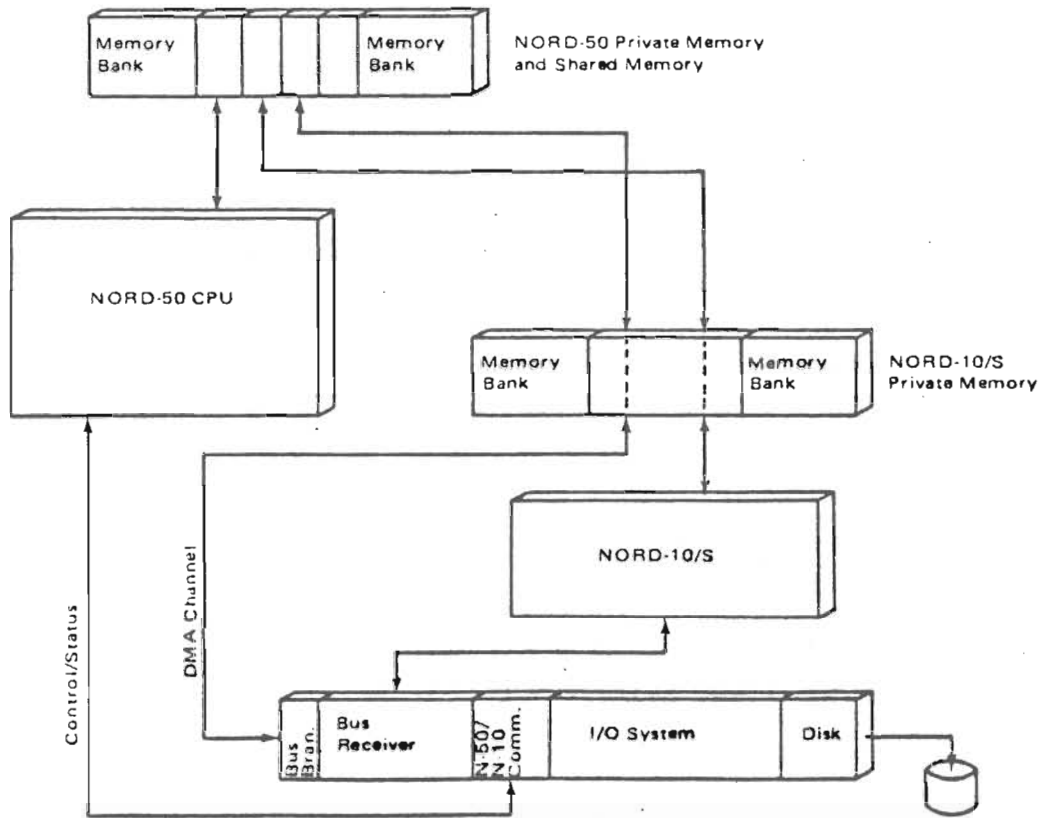

FIGURE 4.1: SINGLE NORD-50 CONFIGURATION

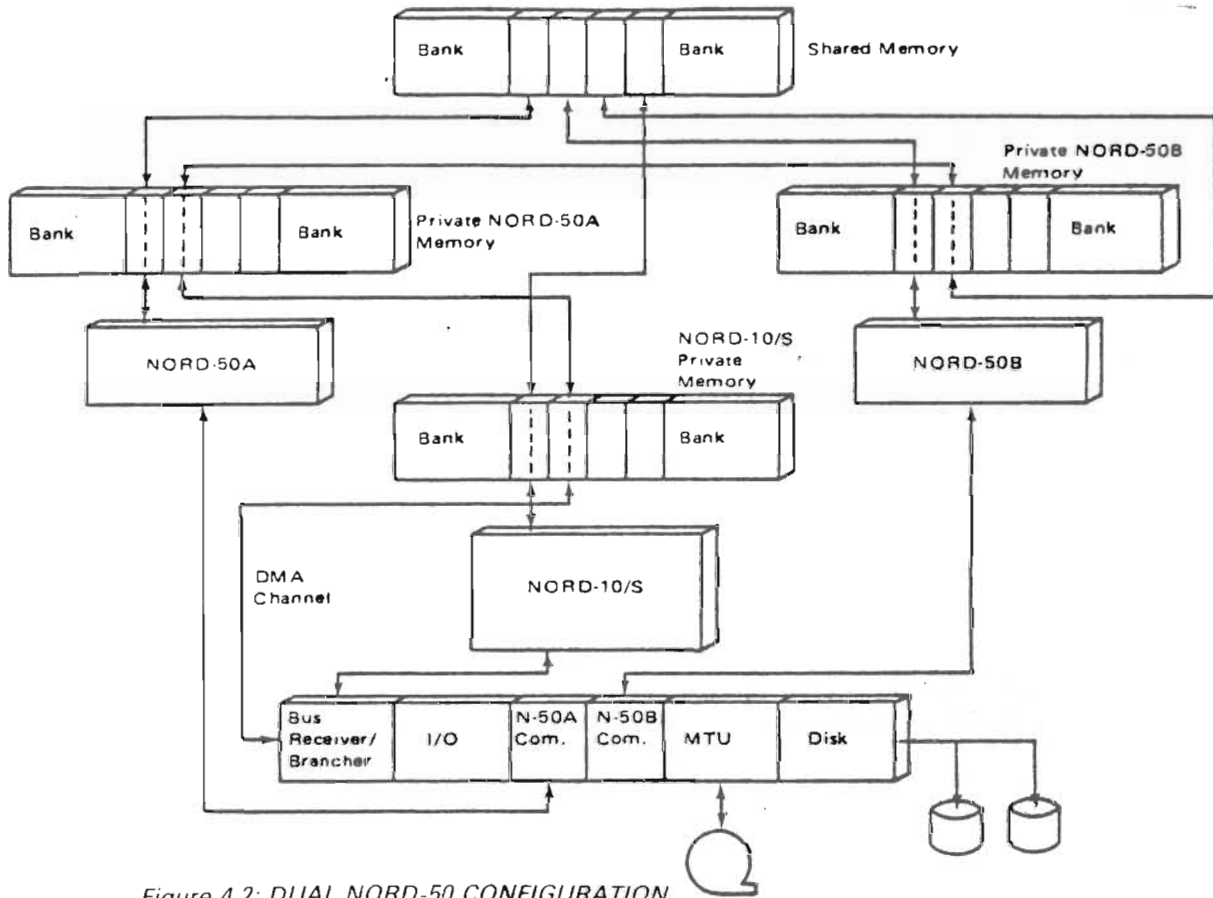

Figure 4.2: DUAL NORD-50 CONFIGURATION

### 4.2.3 *A Multiple Configuration Example*

Figure 4.3 shows the F-16 flight simulator computer complex. 5 processors are used, 1 NORD-10/S and 4 NORD-50s.

The computer complex consists of 6 cabinets, one for each processor plus a special I/O cabinet. The NORD-10/S with its private multiport memory and I/O system is contained in one cabinet. The 4 NORD-50s are in four separate cabinets.

In the I/O cabinet the following is found:

- 3 I/O crates for connecting the customer produced I/O interfaces. The interfaces will access the memory via UNIVERSAL DMA modules supplied by ND.
- Shared memory  
Multiport memory accessible from all the processors and in addition the DISK DMA channel.
- 16 and 32 bit multiplexors for accessing the 4 port shared memory.
- Plug-panels for connecting the customer produced DMA channels directly to ports in the multiport memory system (LFI1, LFI2 and LFI3).
- Channel amplifiers for amplifying the DMA channel having access to the multiport memory located in all 6 cabinets.

Figure 4.3 shows the cabinet layout, while figure 4.4 shows the way the processors are interconnected.

# SYSTEM CONFIGURATION F16

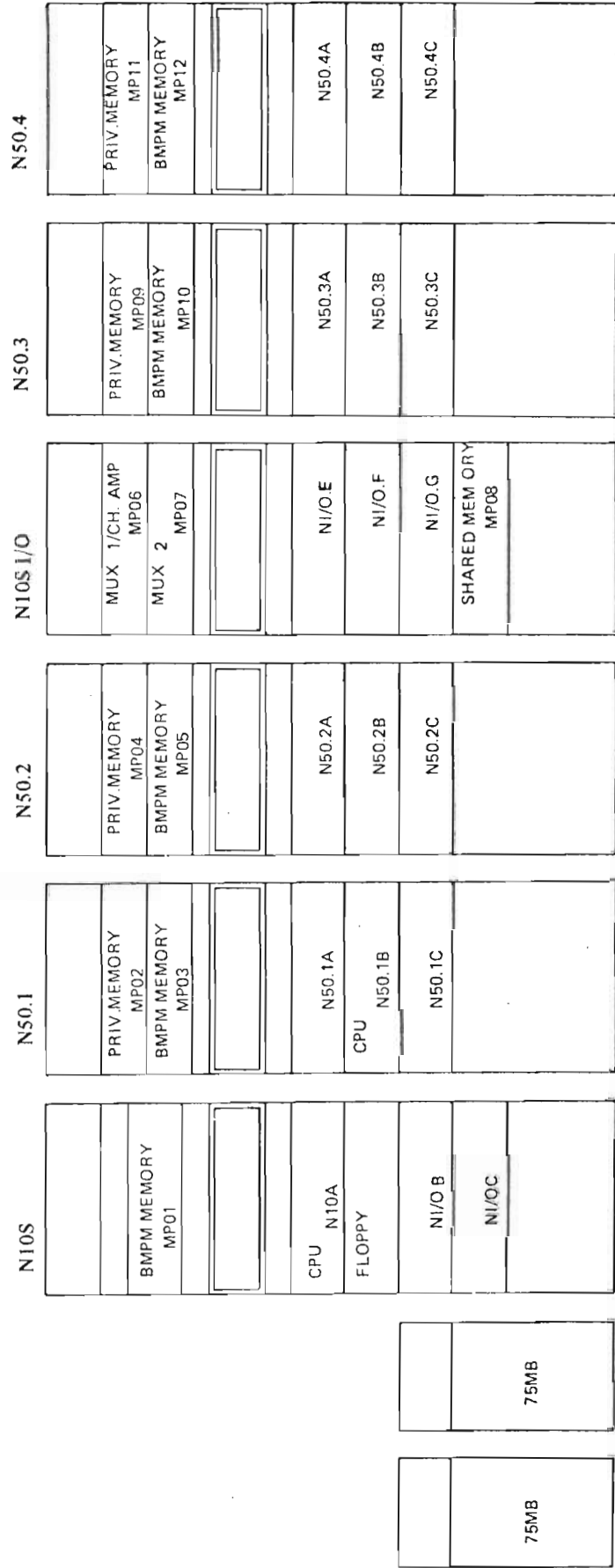

Figure 4.3: SYSTEM CONFIGURATION F16

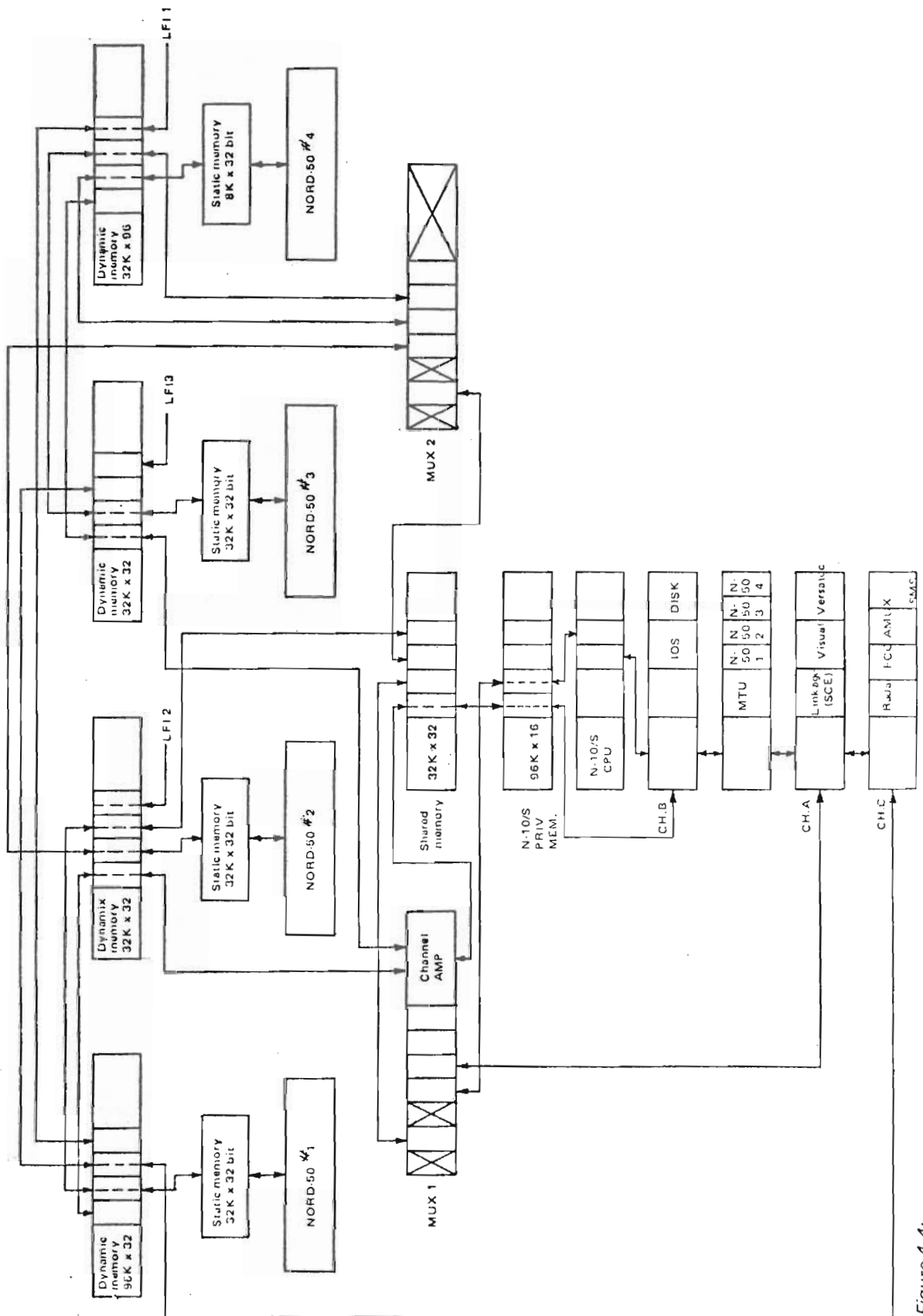

Figure 4.4:

#### 4.2.4 *NORD-50 Construction Principles*

The following pages contain diagrams showing the general construction of a NORD-50.

Figure 4.5 gives an overview of the placement of the various components in the cabinet.

The NORD-50 interconnections with NORD-10/S and memory are shown in figure 4.6.

Figure 4.7 shows the power distribution in a typical NORD-50 installation.

#### *WARNING*

*Objects should not be placed on top of the computer if they can fall through the air holes or hinder air circulation.*

- ① N-10/S power supply unit no.1
- ② Operator's panel
- ③ Crate A
- ④ Fan for crate A
- ⑤ Crate B
- ⑥ Crate C
- ⑦ Fan for crate B and C (with filter)
- ⑧ N-10/S power supply unit no. 2
- ⑨ Power panel 115V or 230V AC
- ⑩ 5V-100A/150A power supply subunit
- ⑪ Crate M1 (Multipart memory MPM)
- ⑫ Fan for crates M1 and M2
- ⑬ Crate M2 (MPM)
- ⑭ Space for 5V-100A power supply subunit
- ⑮ Terminal no.1
- ⑯ Frame for double MPM

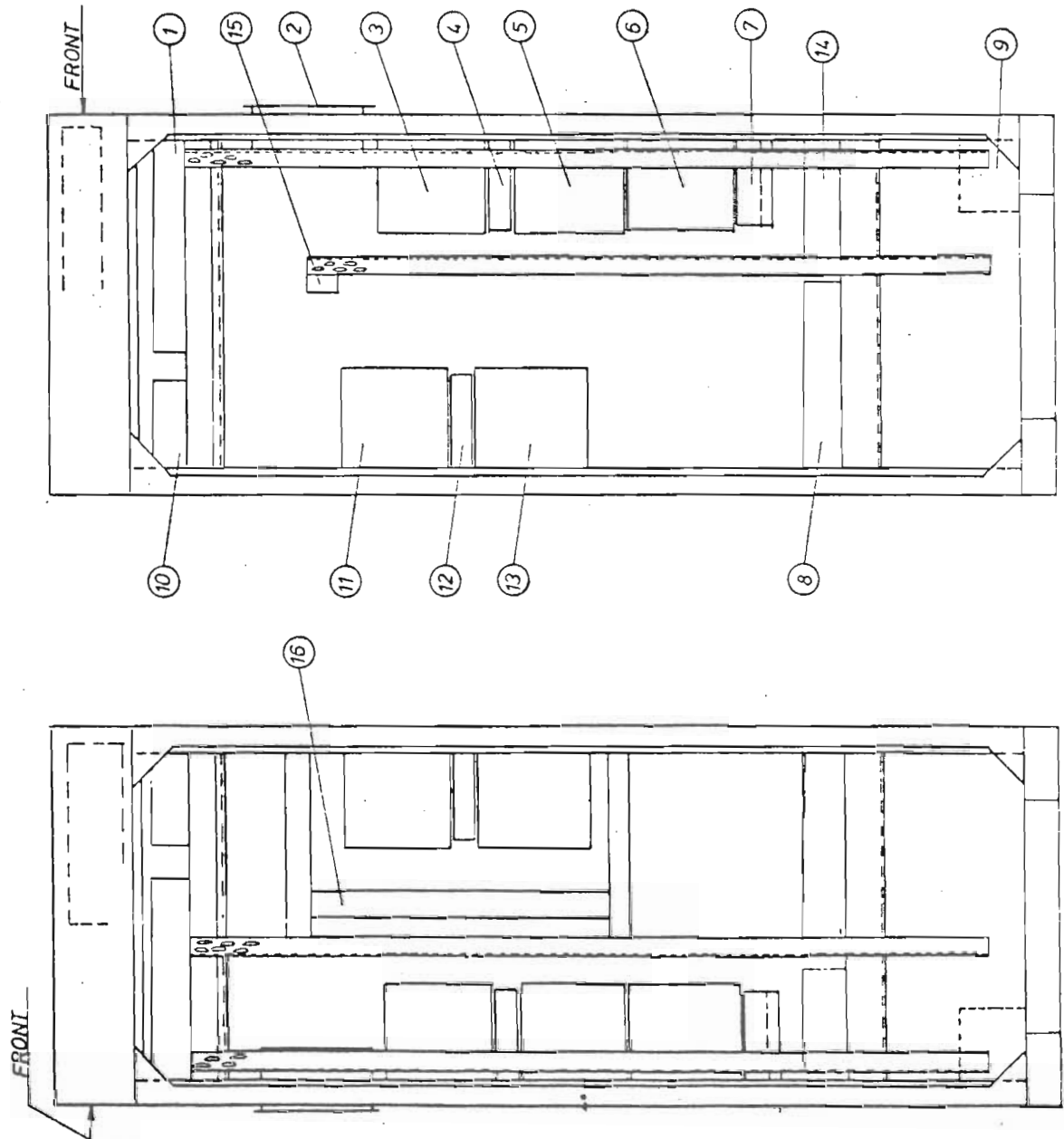

Figure 1-5 SYSTEM CONFIGURATION FIG

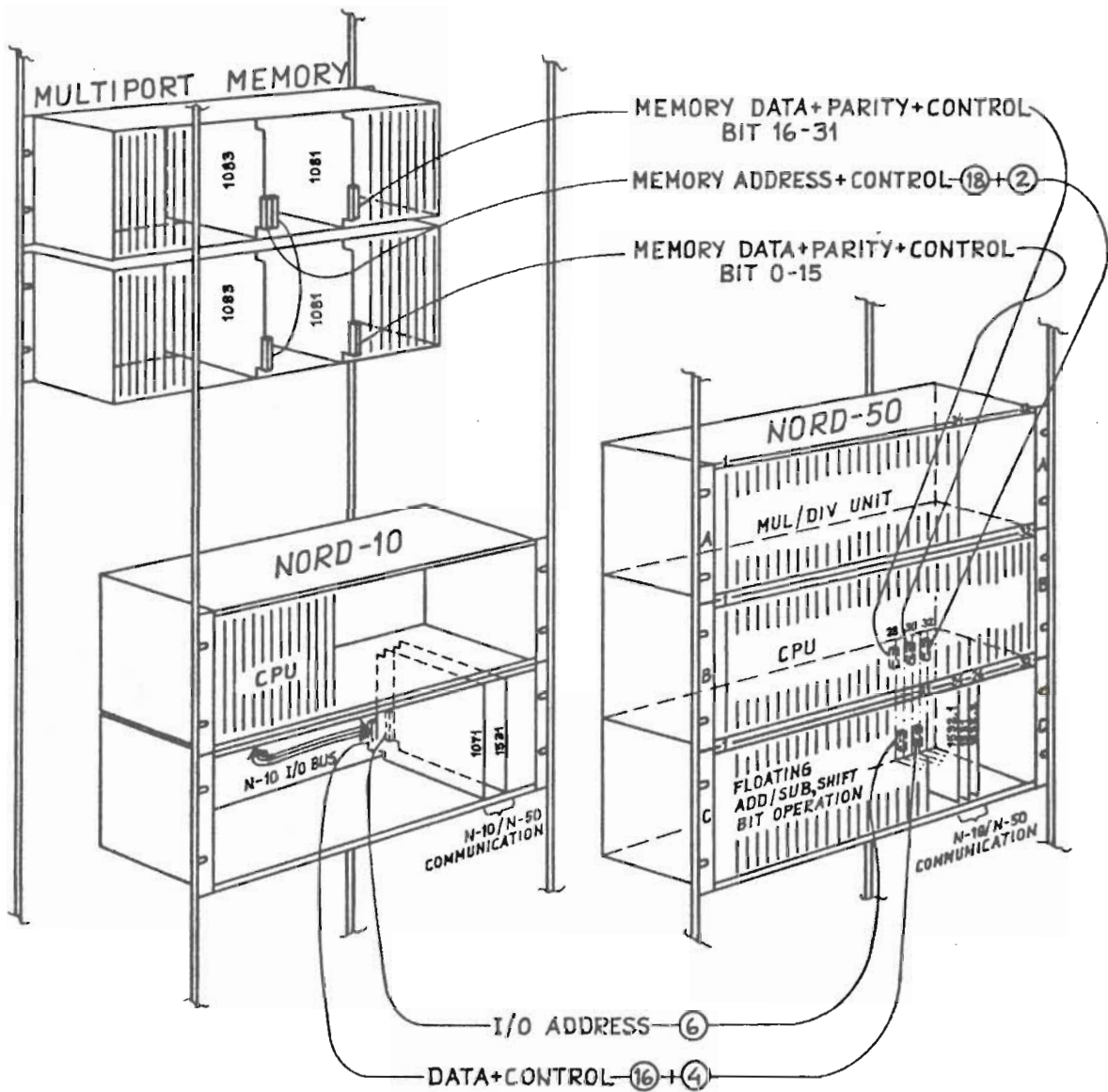

Figure 4.6: NORD-10—NORD-50 CONFIGURATION

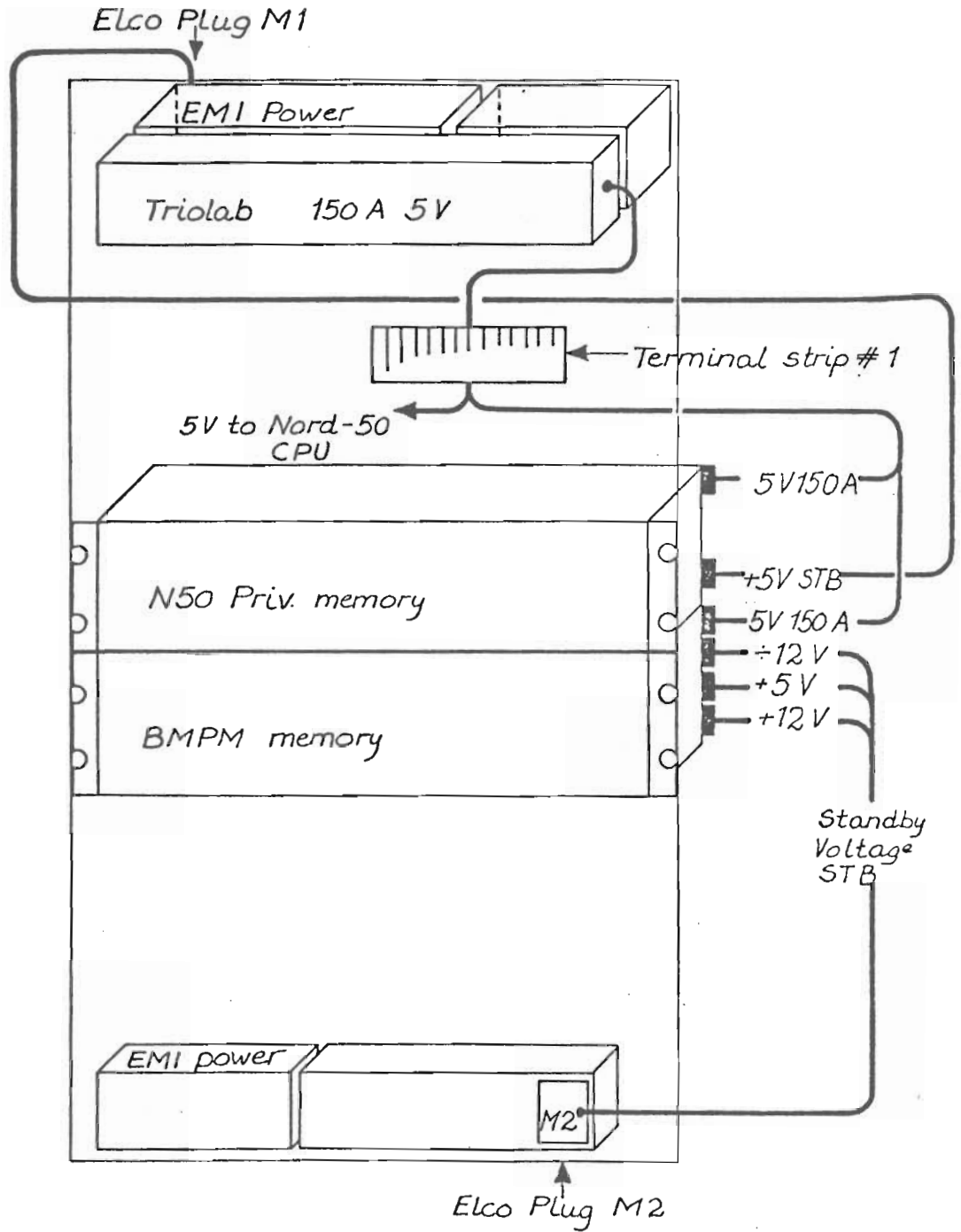

Figure 4.7: POWER DISTRIBUTION IN F-16 CONFIGURATION (NORD-50 REAR VIEW)



#### 4.2.5 *NORD-50 CRATES*

The NORD-50 consists of three 19 inch crates. These crates are also referred to as crates A, B and C.

The A crate contains hardware logic for:

- Integer multiply/divide  
and
- Floating multiply/divide  
(both single and double precision)

The C crate contains hardware logic for:

- Shift operations
- Bit operations
- Convert operations  
(floating to integer and integer to floating)
- Floating add/subtract  
(single and double precision)
- NORD-10/NORD-50 communication

The B crate contains logic for the administration of the A and C crates, also referred to as "External-Arithmetic". More information about the CPU is given in the next section.

#### 4.2.6 *The NORD-50 CPU*

The NORD-50 CPU contains the main registers and arithmetic, the communication registers NORD-10/NORD-50, memory address and data lines and line drivers/receivers for external arithmetic.

These functions are organized on three different circuit boards, each handling four bits:

Address Arithmetic	1501
Register	1502
Arithmetic Buffer	1503

The 32 bit CPU uses eight of each boards, making a total of 24 boards.

The timing and control section of the CPU uses eight different boards:

NORD-50 I/O Control	1500
NORD-50 Controller	1504
Register Address	1505
Cycle Counter	1506
Arithmetic Control	1507
Chip Select	1508
Instruction Control	1510
Timing Control	1519

#### 4.2.7 *NORD-10/NORD-50 Connections*

NORD-10 looks upon NORD-50 as an I/O device connected to the NORD-10 I/O system.

There are two NORD-50 interface modules in NORD-10, the 1071 card for data and control and the 1532.II card for addresses.

The communication between NORD-10 and NORD-50 in addition to common memory takes place on two differential lines, one for data (16 bits) + control (4 bits) and one for I/O address (6 bits).

At start-up time, the start address and stop conditions are transferred to NORD-50. When the NORD-50 stops, a status register indicates the stop reason. The status register is available on the communication lines.

If the interrupt system in the NORD-10 is turned on and the NORD-50 interface is enabled for interrupts, the NORD-10 may execute in parallel with the NORD-50.

Only when an interrupt occurs will the NORD-10 be engaged to identify the interrupt source.

In NORD-50, three modules take care of the communication with NORD-10, the 1532.II, 1531 and the 1532.I modules located in the C-crate.

## 4.2.8 *NORD-50 Memory Connections*

NORD-50 may be connected to physically the same memory as NORD-10 via one port in the multiport memory system (shared memory) or to a separate multiport memory system as a private memory.

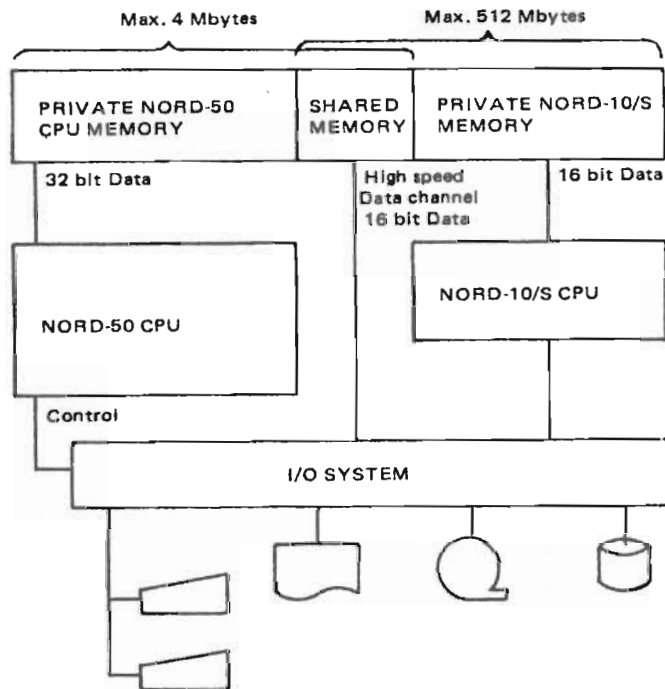

### *NORD-50 COMPUTER SYSTEM*

NORD-50 supplies differential address lines of 20 bits + 2 control signals to the port via a 1 to 1 cable.

For carrying the 32 bit data word, two cables with differential lines are used, one for bits 0-15 plus 2 parity bits, and one for bits 16-31 plus 2 parity bits.

In memory (the multiport memory system), NORD-50 occupies one port out of four. The remaining three are used by NORD-10, DMA mass-storage devices, and the third may be used by a second NORD-50.

The address area each port can see is set up by lower and upper limit switches on the address module (1142) in the multiport system. In this way, NORD-10 and NORD-50 can have locations of private and shared memory.

The priority for NORD-10 or NORD-50 requests is fixed and determined by the physical position of the data receiver/driver module and the address receiver module in the multiport crate.

The 32 bit memory word is divided between two 18 bit memory banks with identical memory addresses. The bank in the upper multiport crate takes care of bits 16-31, while the bank in the lower crate takes care of bits 0-15.

NORD-50 receives two sets of data ready/address ready signals from the memory modules in the two banks. These signals are supplied via the data module (1143) to NORD-50 where the signals are latched, waiting for the last one to appear.

### 4.3 *NORD-50 OPERATOR'S PANEL*

#### 4.3.1 *Lights*

The purpose of the lights on the operator's panel is to give the operator information about:

- Whether the NORD-50 is active or not active.  
Light in indicator STOP or indicator RUN.
- STOP reason  
Light in EXTERNAL STOP if stopped by NORD-10/S. Light in STATUS BREAK if error detected in NORD-50 (overflow, underflow or instruction hangup).
- MODE of operation  
Light in SIMULATE INSTRUCTION or SIMULATE DATA if NORD-50 instruction/data is supplied from the NORD-10/S via the input/output system.  
Light in MEMORY EXAMINE/DEPOSIT if the NORD-10/S is examining or depositing into the NORD-50 memory.
- Program execution address  
Push DISPLAY PC and the program counter is displayed in the ACTIVE ADDRESS field (See figure 4.9). The address is displayed in 4K blocks (address from 0-4K = light in 1 etc.---)
- Data reference address  
Push DISPLAY DATA REF and the memory data reference address is displayed as above.
- Memory Parity error  
Light in PARITY ERROR  
The parity error occurred during one of the following types of read operation (a light will show which one):
  - \* Instruction Read
  - \* Indirect Reference
  - \* Data Reference

The byte where the parity error occurred is also displayed (BYTE 3,2,1 and 0).

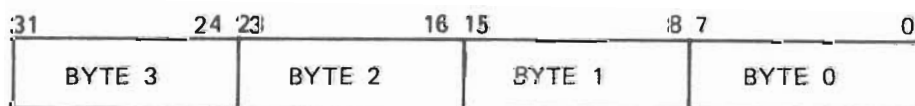

### 4.3.2 *Push Buttons And Key*

Two push buttons were described under program execution address and data reference address. These were the following buttons:

- DISPLAY PC
- DISPLAY DATA REF

In addition, the button:

- POWER ON/OFF

is used to turn on and turn off the power supply for the NORD-50. This button should not be used often since the power should be turned off only in special cases.

Finally, the:

- PANEL KEY LOCK

is used to lock the panel and disable the push buttons. The operator's panel is illustrated in figure 4.8.

#### *NOTE*

All NORD-10s and NORD-50s in one computer complex must be turned on during operation (even if they are not all to be used).

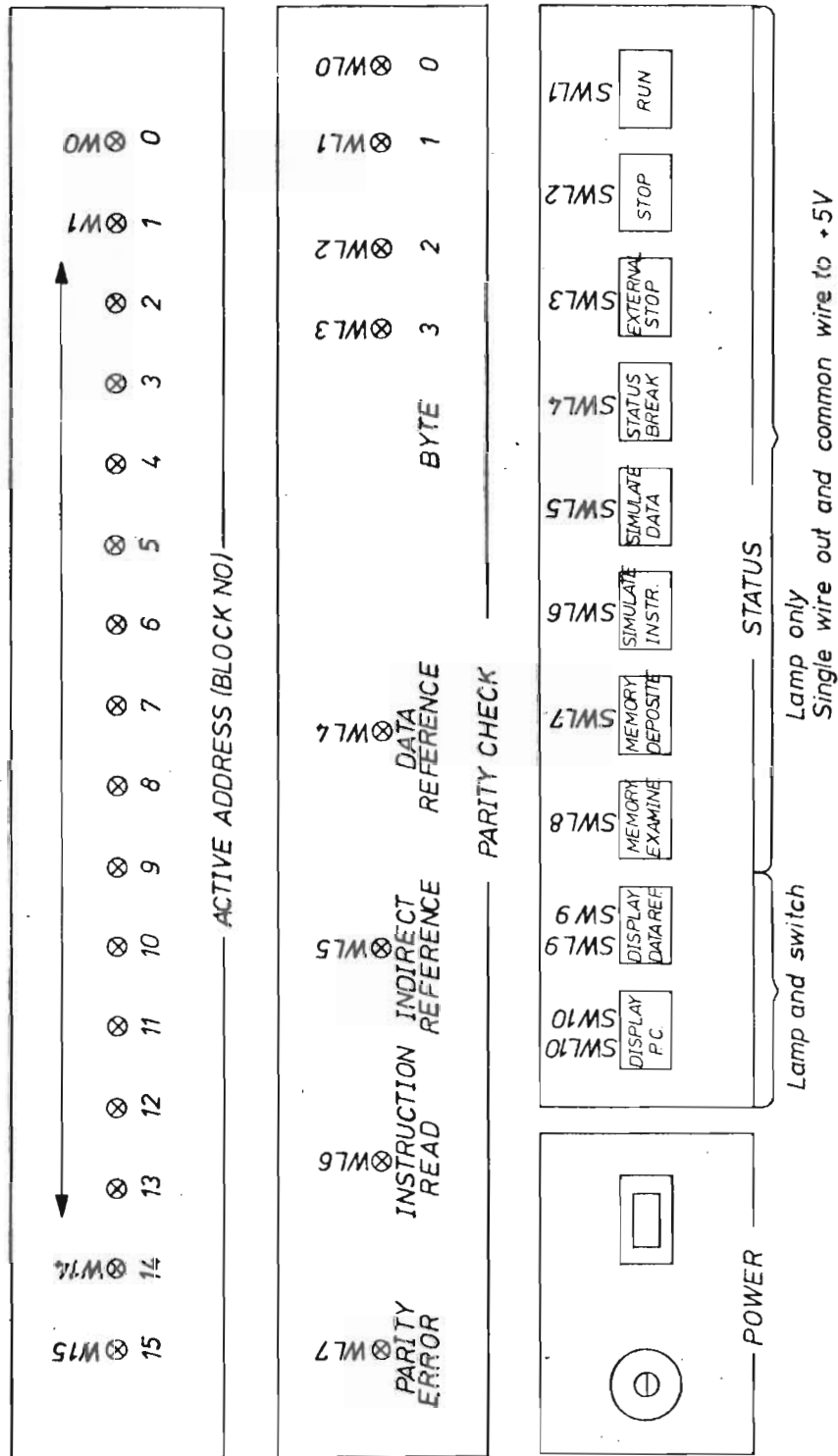

Figure 4.8: OPERATOR'S PANEL



## 4.4 *NORD-50 MONITOR*

The NORD-50 monitor is a sub-system in the SINTRAN operating system supervising execution of NORD-50 programs.

In order to use the monitor, it must have been loaded into the SINTRAN system as a real-time (RT) program. (For a description of how to do this, see the SINTRAN III User's Guide and the RT-Loader Manual.) The monitor is then started under SINTRAN by typing:

```
@N-50
```

on a terminal connected to the system.

The main tasks of the monitor are:

- Loading programs from files into NORD-50 memory. These programs must have an executable format prepared by the NORD-50 loader. (:NOR5)
- Starting the programs.
- Reporting errors during program execution.
- Examining the NORD-50 registers/memory after the programs have come to a stop (normal or abnormal stop).

### 4.4.1 *Command Summary*

*The \* is written by the monitor*

*PLACE	<file name or number>	Load a program
*RUN		Start execution of the placed program
*LOAD	<file name or number>	Load and start execution of a program, i.e., PLACE and RUN
*GO TO	<address>	Start in given address

See the NORD-50 Monitor User's Guide for more details about the NORD-50 monitor.

## 4.5 *NORD-50 MAINTENANCE*

Preventative maintenance for the NORD-50 is the same as for the NORD-10/S. See section 3.1.

The malfunctioning of a NORD-50 will normally be reported to the operator via the NORD-50 monitor program running in the NORD-10/S. The next step then is to run test programs.

The test programs for the NORD-50 can be divided into three groups:

1. Test programs running in the NORD-10/S.
2. Test programs running in the NORD-50. For running this group of programs the NORD-50 monitor must be working.
3. Verification programs (timing programs, benchmarks, etc.).

Common for the test programs in the first two groups is that there are two categories; one for testing the NORD-50 CPU and the other for testing the NORD-50 memory.

### 4.5.1 *Test Programs Running In The NORD-10/S*

— Testing the CPU

The NORD-50 TEST-SYSTEM is a stand-alone program that will test all the NORD-50 instructions. The program will set the NORD-50 in SIMULATE MODE and instructions and data will be supplied via the NORD-10/S I/O system. The result of the test is read back to the NORD-10/S and compared with an "EXPECTED TABLE" located in the NORD-10/S memory.

LOAD and RUN procedure:

1. STOP the NORD-10/S
2. Insert the floppy diskette in the floppy drive
3. Write 1560& on terminal number 1
4. Write LOAD-N50TEST-SYS on terminal number 1 and the test program is loaded from the floppy and started

— Testing the memory

- a) For testing the memory shared between the NORD-10/S and the NORD-50, all the NORD-10/S memory test programs are available (MOVER, MULTI, etc., see chapter 3).
- b) Built into the NORD-50 monitor is a command that tests the NORD-50 memory:

\*TEST-MEM

When the command is given, NORD-50 is set in MEMORY EXAMINE/DEPOSIT MODE by the monitor. Data and addresses are then supplied automatically from the NORD-10/S via the NORD-50 CPU to the NORD-50 memory, private or shared. The test is performed by reversing the data flow and checking the received data. More information about the test is found in Appendix C-1.

- c) For testing the memory shared between the universal DMA interface and NORD-50, a stand-alone test program is available:

MEM-TEST-2304

- d) For examining the memory configuration (i.e., determining the parts of memory that are shared and what they are shared between), a stand-alone program can be used:

MEMORY-MAP-2317

## 4.5.2 *Tests Running In The NORD-50*

### — Testing the CPU

The test programs listed below test the NORD-50 CPU. These programs are loaded from disk and started with the NORD-50 monitor using the \*LOAD command.

TINST	% NORD-50 instruction test
TREG	% Register test
ITEST	% Integer multiply/divide test
HAMBURG	% Floating add/subtract and multiply/divide test
FTEST	% Floating multiply/divide test
DFTEST	% Double precision multiply/divide test

### — Testing the memory

The NORD-50 memory is tested with the program

TMEM

loaded and started with the \*LOAD command to the NORD-50 monitor. Addresses are specified so that all or any part of the shared memory, the high speed static memory or the NORD-50 private memory can be tested. More information about this test is found in Appendix C-2.

## 4.5.3 *Verification Programs*

If the test programs indicate that everything is OK, it may be interesting to run the verification programs:

SEKUND	times the various instructions
BM2	ASEA benchmark
TCOR-NGO	NGO benchmark

These are also run under the NORD-50 monitor with the \*LOAD command. They are described in Appendix C-3.

4.5.4 NORD-50 Test-Sequence

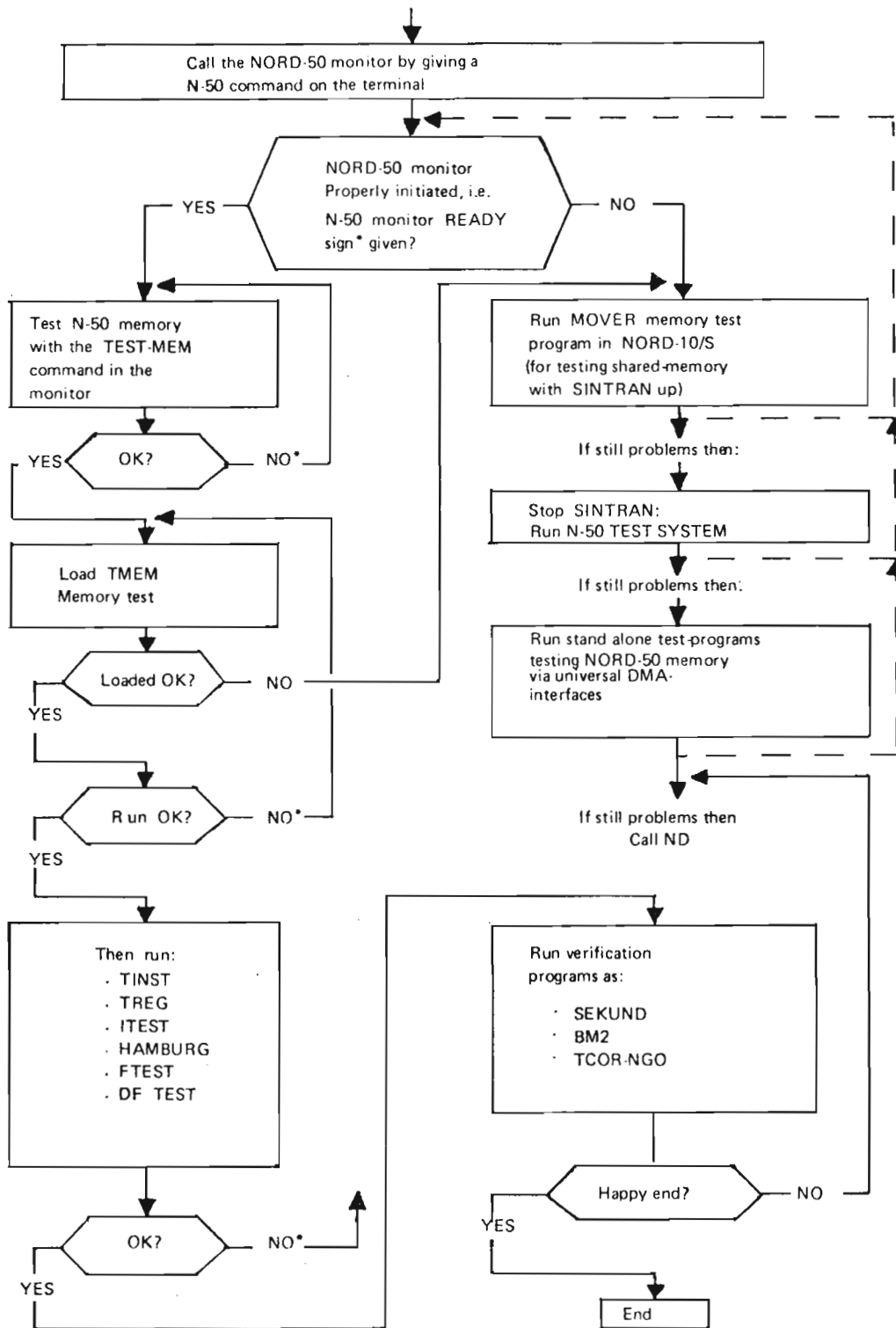

NO\* = CALL ND or CHANGE FAILING MODULE IF NEW MODULE AVAILABLE AND REPEAT THE TEST



## APPENDIX A

## DOCUMENTATION REVIEW

The following manuals will be of interest to the operator. They are listed in order of priority, i.e. the SYSTEM SUPERVISOR is the most important, etc.

*NORD-10/S Manuals*

## 1. SINTRAN III SYSTEM SUPERVISOR

This is the main handbook for an operator who has the main responsibility for managing a NORD-10 installation. It contains information about the hardware and software necessary for running a NORD installation, explanations of error messages, instructions on how to set up SINTRAN and associated system files, how to change switch settings on interface boards, etc.

The system supervisor should be familiar with this manual and know what information may be found there.

## 2. TEST PROGRAM DESCRIPTIONS

This contains instructions for the running of such programs as:

MOVER	memory test program
TECOD	test program for 10Mb disks
DISC-TEMA	utility program for disks
MCOPY	mag-tape to/from disk utility
CACHE	test program
ERRCOR	test program for error correction logic

FILE SYSTEM INVESTIGATOR program

## NOTE:

The descriptions of other test programs will be found in the documentation accompanying the test-diskettes they come on.

## 3. NORD 10 VERIFICATION PROGRAMS

This gives detailed instructions on how to run the CPU test programs:

ONE-CHECK  
 TWO-CHECK  
 THREE-CHECK  
 FOUR-CHECK  
 10-FLOATING  
 NORD-10 MICRO-PROGRAMMED MEMORY TEST

4. NORD-10/S GENERAL DESCRIPTION

This contains a short description of the main components of the NORD-10/S, followed by a description of the circuits found on each printed circuit board.

5. NORD-10/S FUNCTIONAL DESCRIPTION

This manual contains information about the way the NORD-10/S works. The system architecture, I/O system, interrupt system, memory management system and operator communication are described in detail.

6. NORD-10/S INPUT/OUTPUT SYSTEM

This describes the I/O system for the NORD-10/S in detail, I/O bus architecture, programmed input/output, the I/O interrupt system and direct memory access transfers.

*NORD-50 Manuals*

1. NORD-50 TEST SYSTEM

This manual contains a detailed description of the stand-alone test program running in the NORD-10/S to test the NORD-50 CPU.

2. NORD-50 GENERAL DESCRIPTION

This contains a short description of the main components of the NORD-50, followed by a description of the circuits found on each printed circuit board.

3. NORD-50 FUNCTIONAL DESCRIPTION

This manual contains information about the way the NORD-50 works. The floating point number representation, the CPU, and the external arithmetic crates are described in detail.

4. NORD-10/NORD-50 COMMUNICATION SYSTEM

This contains a detailed description of the communication hardware used in a NORD-10/NORD-50 system.



## APPENDIX B

### TEST PROGRAM OVERVIEW

On the next page a cross reference between the ND-test programs and the hardware they test is given.

Both NORD-10 and NORD-50 test programs are included.

ND NO.	SOFTWARE REG. NO.		TEST PROGRAM	TEST NO.
	TEST	PROGRAM		
020	NORD.10/S CPU			ONE CHECK 1192
011	MEM.MANAGEMENT			EXTEN. ONE 1519
050	NORD.50.1			TWO CHECK 1190
050	NORD.50.2			THREE CHECK 1525
050	NORD.50.3			FOUR CHECK 1418
050	NORD.50.4			RG CHECK 1543
021	CACHE			T.32B-FLOAT 1860
136	MULTI-PORT DRIVER			PFAIL 1357
145	1 BANK MEM.PORT			TEST PAGE 1358
147	DUAL BANK MEM.PT.			N51-TSYS 1892
158	32 BIT 4 PORT MEM.			N52-TSYS 1892
156	MOS MEMORY 32K			N53-TSYS 1393
150	16 BITS MUX			N54-TSYS 1892
151	16 BITS CH. AMP			TINST-50 1840
159	32 BITS MUX			TREG50 1842
051	STATIC MEMORY			ITEST
052	8K STATIC			FTEST
164	BUS MEM. BRANCHER			DFTEST
174	16 MEM. ADDR. REG.			SEKUND
167	DMA ADDR. EXT.			CACHE 2063
558	ECC DISK CONTR.			MOVER 1365
567	DMA CONTROLLER			MULTI 1820
514	DISK DRIVE 75 Mb			T32K MOS 2178
652	VERSATEC CONTR.			MPM-MAINT 2177
850	16 BIT UNIV. DMA			TMEM-50 1841
851	DMA DIFF. TRANS.			MEM-TEST 2304
163	BUS RECEIVER			S1172-HAR 2235
260	TERM. INTERF. 4 LINE			DS1172 2282
358	FLOPPY DISK CONTR.			SUPER-RAND 2222
450	CARD READER			SIGFUNC 1824
458	LINE PRINTER			PASCAN 2226
711	ASYNC. MODEM			GREMS 2231
816	EXT. INTERRUPTS			ECCTEST 2224
023	PROG. RTC			VERSATEST 2297
811	DIGITAL OUTPUT			TTEST 1206
				FL-LOOPS 1996
				FLOPP-FORM 1990
				FLOPPY-FU 1986
				FLOPPY-RAN 1988
				CARDR 1642
				LP-TEST 1878
				INTER-T 2233
				TREAL 1399
				CONFI-INV 1672

TEST MATRIX FOR F-16 CONFIGURATION

## APPENDIX C

## NORD-50 MEMORY TEST PROGRAMS

## C.1 TEST-MEM MONITOR COMMAND

- NORD-50 memory test program in the NORD-50 monitor (command in the monitor)
- NORD-50 memory tested by depositing/examining the memory via the NORD-10/S Input/Output System
- NORD-50 memory tested in decimal increments of 1K
- Patterns: 0
  - 1
  - 25252525252
  - 12525252525
  - 37700177400
  - 37777600000
  - 00000177777
- Address in address test (2 x 16 bits address)
- Error printouts:
  - Pattern test failing
  - Address test failing
- Looping possible if this command is given before program start

\*LOOP-ON

Program will loop and if error, failing pattern will be repeated

\*LOOP-OFF

\*NB! Remember Break Conditions

Examples of Error Printout:

```
*LOOP-ON
*TEST-MEM
START ADDRESS: 0
NUMBER OF 1K BLOCKS TO BE TESTED : 10
ADDRESS IN ADDRESS TEST FAILING
ADDRESS      WRITTEN      READ
0000000    000000000000    00000400002
```

\*

## C.2 TMEM — N-50 MEMORY TEST PROGRAM

NORD-50 Memory Test Program: — TMEM — 1841

- Test program testing and running in NORD-50 memory
- Loaded and started via the NORD-50 monitor
- The following tests may be specified:

Test 1\* : Store/Read 0

Test 2\* : Store/Read — 1

Test 3\* : Address in address test (2 x 16 bits address)

Test 4\* : Address in address test with inverse address

Test 5\*\* : Walking tests

a) writes a pattern in the test area

b) writes a pattern inverted in the first location

c) check that no other locations are changed

d) rest inverted pattern

\* = Fast tests

\*\* = Overnight test

- Start address = 0
- Examples of Printout:

```
*LOAD TMEM
```

```
THIS IS YOUR N-50 MOS MEMORY TEST PROGRAM
THE PROGRAM OCCUPIES LOCATIONS: 0000000 TO 0001227
LOWER TEST ADDRESS(OCTAL): 1230
UPPER TEST ADDRESS(OCTAL): 37777
SPECIFY TESTS TO BE RUN BY OCTAL
NUMBERS TERM. BY CR.STOPS WHEN 0 IS TYPED
77 MEANS ALL TESTS
1
2
3
4
0
```

```
WANT TESTS TO LOOP? 0:NO 1:YES
0
```

```
ERRORS WILL BE REPORTED IN THE FOLLOWING FORMAT
TEST1,2,3,4: <FAILING ADDR.>,<FOUND DATA>,<EXP. DATA>,<TEST NO>
TEST5: <WALK PATT. ADDR.>,<SAME AS ABOVE>,<READ/WRITE>
```

```
0030000 37773777777 37777777777 0000002
0030001 37773777777 37777777777 0000002
0030002 37773777777 37777777777 0000002
0030003 37773777777 37777777777 0000002
0030004 37773777777 37777777777 0000002
```

```
TEST1,2,3,4: <FAILING ADDR.>,<FOUND DATA>,<EXP. DATA>,<TEST NO>
TEST5: <WALK PATT. ADDR.>,<SAME AS ABOVE>,<READ/WRITE>
```

```
0100302 0100000 30000400000 25252525252 0000005 WRITE ERROR
0100302 0100001 00000100116 25252525252 0000005 WRITE ERROR
0100302 0100002 00223050000 25252525252 0000005 WRITE ERROR
0100302 0100003 00267040001 25252525252 0000005 WRITE ERROR
0100302 0100004 24040010000 25252525252 0000005 WRITE ERROR
```

ND-30.001.01

### C.3 VERIFICATION PROGRAMS

In this appendix a printout of a successful run of the following verification programs is found:

1. SEKUND
2. BM % ASEA BENCHMARK
3. TCOR-NGO % NGO BENCHMARK

## APPENDIX C3—1

## NORD-50 VERIFICATION PROGRAM — SEKUND

- Each instruction is run  $10 \cdot 10^6$  times
- Example of printout:

```
*LOAD SEKUND
LDR 1.38
STR 1.51
ADD 1.37
LDF 2.13
STF 2.25
FAD 1.92
FADD 2.51
RAF 1.08
RAFD 1.08
FMU 4.43
RMF 3.52
RMFD 6.71
FDV 4.44
FDVD 8.17
RDF 3.53
RAD 0.61
ADDA 0.61
MPY 5.34
DIV 2.33
ADM 2.12
SLR 1.07
SLRD 1.07
JFM- 0.62
EXC' 1.14
EXC" 1.82
JFM+ 1.20
- *** END *** - AT: 000015
```

## APPENDIX C3-2

\*OPEN TERM 5 W  
\*LOAD BM2

BENCHMARK 2

0.86474	66	22
0.00000	66	22
0.90386	66	22
0.00000	66	22
0.91508	66	22
1.00378	66	22
1.01144	66	22
1.01069	66	22
1.00942	66	20
1.00840	66	22
1.00758	66	22
1.00694	66	22
1.00645	66	22
1.00602	66	22
1.00563	66	22
1.00533	66	22
1.00506	66	22
1.00481	66	22
1.00462	66	22
1.00443	66	22

TOTAL TIME(S/100) 1800

- \*\*\* END \*\*\* - AT: 0000015 -  
\*CC FIRST RESULT SHOULD BE 0.86474  
\*CC LAST RESULT SHOULD BE 1.00443  
\*CC TIME SHOULD BE APP. 25.5 S

APPENDIX C3-3

\*OPEN TCOR-DATA:DATA 5 R  
 \*OPEN TERM 6 W  
 \*LOAD TCOR-NGO

TERRAIN CORRECTION INCREMENT FR. NM RADIUS. CHECK AGAINST UNNORMAL VALUES

DISTANCE NM	0	0.002	0.068	0.23	0.59	0.90	1.28	1.75	2.29	2.87	3.52	5.24	8.44	12.4	18.8	28.8	58.8	99.0	166.7	CIRCLE
E28T063	0.00	0.00	0.00	0.00	1.07	1.87	0.39	0.82	0.47	0.58	0.44	0.451	0.220	0.075	0.027	0.014	0.009	0.011	0.011	0.011
D28T080	0.00	0.00	0.00	0.00	1.42	1.30	0.72	0.95	0.59	0.75	0.35	0.091	0.088	0.040	0.032	0.040	0.019	0.014	0.012	0.012
D28T110	0.00	0.00	0.00	0.00	0.21	0.89	0.00	0.86	0.75	1.21	0.72	0.244	0.133	0.073	0.035	0.017	0.016	0.012	0.012	0.012
D28T100	0.00	0.00	0.00	0.00	7.57	1.11	6.83	2.70	2.00	0.54	0.73	0.438	0.217	0.057	0.023	0.010	0.009	0.009	0.010	0.010
D28T061	0.00	0.00	0.00	0.00	3.87	2.94	4.25	3.32	2.59	1.37	0.83	0.538	0.355	0.208	0.125	0.078	0.037	0.022	0.017	0.017
D28N012	0.00	0.00	0.00	0.00	0.18	0.03	0.33	0.12	0.88	0.46	0.74	0.417	0.374	0.260	0.132	0.076	0.006	0.001	0.001	0.001
D28T097	0.00	0.00	0.00	0.00	7.15	12.30	0.00	3.99	1.39	0.59	0.45	0.143	0.060	0.054	0.062	0.055	0.020	0.013	0.011	0.011
E28T062	0.00	0.00	0.00	0.00	2.42	2.24	1.18	0.61	0.57	0.57	0.52	0.432	0.309	0.085	0.037	0.022	0.012	0.011	0.011	0.011
D28T092	0.00	0.00	0.00	0.00	1.75	4.85	2.79	4.54	3.57	2.59	1.93	1.627	0.513	0.136	0.058	0.045	0.035	0.016	0.014	0.014
D28T102	0.00	0.00	0.00	0.00	9.45	7.42	6.30	3.43	2.66	1.47	0.97	0.674	0.472	0.239	0.113	0.053	0.034	0.020	0.016	0.016

STATION      LATITUDE      LONGITUDE      ELEVATION      LAYER      TERRAIN      FREEAIR      BOUGUER ANOMALY

E28T063	62 11.23	8 13.33	1414.4	159.58	5.99	436.08	-60.62
D28T080	62 11.62	7 50.32	1507.1	169.99	6.04	464.65	-64.25
D28T110	62 13.28	7 58.51	1445.8	163.10	5.96	445.76	-65.38
D28T100	62 13.43	8 7.69	1315.5	148.47	12.24	405.60	-63.75
D28T061	62 14.36	7 41.21	1755.9	197.90	19.02	541.33	-59.13
D28N012	62 15.90	8 11.30	572.0	64.70	6.18	176.39	-61.87
D28T097	62 16.80	7 46.57	1417.0	159.87	17.88	436.88	-59.00
E28T062	62 17.45	8 16.37	1401.3	158.11	7.73	432.04	-56.75
D28T092	62 18.54	8 0.32	1573.2	177.41	17.98	485.02	-59.00
D28T102	62 18.72	7 52.73	1700.2	191.65	19.56	524.16	-58.38

022370 STOP

\*\*\* END \*\*\* - AT: 0000015 -  
 \*\*\* LAST 3 NUMBERS OUT SHOULD BE : 19.56 524.16 -58.38 .



APPENDIX D

PARTS LIST

This list is found in the parts list manual.



## INDEX

A register button	2.2.9
ACTIVE LEVELS button	2.2.9
addresses	2.2.4
ADR button	2.2.9
air filters, cleaning	3.1.1
alarm, power	1.5.2.1
alarm, power supply error	3.3.2
ALD register	2.2.4, 2.3.2
ALREADY FIXED error message 25	3.4.3
Automatic Load Descriptor (ALD)	2.3.3
B (bank number)	2.3.1
B register button	2.2.9
bank number	2.3.1
BATCH INPUT ERROR error message 06	3.4.3
BATCH OUTPUT ERROR error message 07	3.4.3
BATCH SYSTEM ERROR error message 08	3.4.3
binary load	2.3.2
BM2 verification program (NORD-50)	app.c.3.2
bootstrap loader	2.1, 2.3.2
bootstrap loaders	2.3.2
cabinet (NORD-10)	1.4.1
cabinet (NORD-50)	4.2.4
connections, NORD-10/NORD-50	4.2.7
console terminal	2.3
CONTINUE button	2.2.4
CORRECTED MEMORY ERROR error message 44	3.4.3
CPU test programs (NORD-50)	4.5
CPU test programs (NORD-10)	3.6.1
crate (NORD-10) (see also rack)	1.4.1, 1.4.2
crate (NORD-50)	4.2.5
current location counter	2.3.1
D register button	2.2.9
DATA button	2.2.9
data link	1.3.3
DECODE ADDRESS button	2.2.4
DEPOSIT button	2.2.4
DEVICE ERROR error message 23	3.4.3
DISK/DRUM TRANSFER ERROR error message 21	3.4.3
DISK/DRUM TRANSFER ERROR error message 20	3.4.3
DISPLAY DATA REF button	4.3.2
DISPLAY PC button	4.3.2
DIVIDE BY ZERO error message 30	3.4.3
DMA ADR button	2.2.9

ENTER REGISTER button	2.2.4
error code summary	3.4.2
error message codes, file system	3.5
error messages	3.4
error procedures	3.3
errors — operators actions	3.4.3
errors, fatal	3.3
errors, nonfatal	3.4
errors, NORD-50	4.5
EXM button	2.2.9
F-16 system configuration example	4.2.3
FALSE INTERRUPT error message 22	3.4.3
fans	1.4.5
FILE SYSTEM ERROR error message 29	3.4.3
FIXING/DEMAND error message 17	3.4.3
FORTTRAN I/O ERROR error message 91	3.4.3
FORTTRAN RUN-TIME ERROR error message 90	3.4.3
HDLC	1.3.3
I (internal register examine)	2.3.1
ILL. ERROR IN ERMON error message 41	3.4.3
ILL. INSTR. error message 34	3.4.3
ILL. MONITOR CALL error message 00	3.4.3
ILL. PARAM. IN ABSET error message 10	3.4.3
ILL. PARAM. IN CLOCK error message 09	3.4.3
ILL. PARAM. IN CONCT error message 27	3.4.3
ILL. PARAM. IN UPDAT error message 11	3.4.3
ILL. PRIORITY error message 02	3.4.3
ILL. RT-PROG error message 01	3.4.3
ILL. SEGMENT NUMBER error message 15	3.4.3
ILL. TIME PARAM. error message 12	3.4.3
input/output device test programs	3.6.1
INTERNAL INTERRUPT DIR. TASK LEV error message 04	3.4.3
internal register deposit	2.3.1
internal register examine	2.3.1
interrupt indicator	2.2.6
IOX ERROR error message 37	3.4.3
IR button	2.2.9
key — panel lock (NORD-10)	2.2.3
key — panel lock (NORD-50)	4.3.2
L register button	2.2.9
levels, program	2.2.5
LOAD button	2.2.4
loading	2.3.2
loading SINTRAN III	2.4.1
logging in (SINTRAN III)	2.4.1

mains distribution	1.4.3
maintenance, daily	3.1.1
maintenance, monthly	3.1.1
maintenance, ND service dept.	3.1.2
mass storage load	2.3.2
mass storage test programs	3.6.1
MASS STORAGE TIME-OUT error message 26	3.4.3
mass storage utility programs	3.6.1
MASTER CLEAR button	2.2.4
memory configuration test	4.5.1
memory deposit	2.3.1
memory examine	2.3.1
memory modules	1.3.2
MEMORY OUT OF RANGE error message 39	3.4.3
MEMORY PARITY error message 38	3.4.3
memory test microprogram	3.6.2
memory test programs	3.6.1, 4.5
MOPC operator communication	2.1
multi-processor (NORD-50)	4.2.2
multi-processor (NORD-10)	1.3.2
multiport memory	4.2.8
N-50 SINTRIN III command	4.4
NORD-10 multi-processor configuration	1.3.2
NORD-10 single processor configuration	1.3.1
NORD-10/NORD-50 connections	4.2.7
NORD-10/S performance characteristics	1.2
NORD-50 basic configuration	4.2.1
NORD-50 computer system	4.1
NORD-50 CPU attributes	4.1
NORD-50 monitor	4.4
NORD-50 monitor commands	4.4.1
NORD-50 multiple configuration	4.2.2
NORD-50 performance characteristics	4.1.1
NORD-50 test sequence	4.5.4
NORD-50 TEST-SYSTEM	4.5.1
octal load	2.3.2
operator communication	2.1
operator panel (NORD-50)	4.3
operator panel (NORD-10)	1.4.2, 2.2
OURSIDE SEGMENT BOUNDS error message 14	3.4.3
OVERLAPPING SEGMENTS error message 42	3.4.3

P ADR button	2.2.9
P register button	2.2.9
PAGE FAULT FOR NON-DEMAND error message 13	3.4.3
paging indicator	2.2.6
PERMIT VIOLATION error message 31	3.4.3
plug panel	1.6
power alarm	1.5.2.1
power distribution (F-16)	4.2.4
power fail	1.5.3
POWER FAIL error message 40	3.4.3
power on/power off button (NORD-50)	4.3.2
power on/power off button (NORD-10)	2.2.2
power panel	1.4.2, 1.5.2
power supply alarm	3.3.2
power unit	1.5
PRIV. INSTR. error message 36	3.4.3
program levels	2.2.5
R (register examine)	2.3.1
rack (NORD-10) (see also crate)	1.4.1, 1.4.2
register deposit	2.3.1
register examine	2.3.1
registers, displaying	2.2.8
registers, entering	2.2.4, 2.2.7
remote load	1.3.3
remote operation	1.3.3
restart	1.5.3
RESTART button	2.2.4
ring indicator	2.2.6
RING VIOLATION error message 32	3.4.3
RT-FTN STACK ERROR error message 35	3.4.3
SEGMENT NOT LOADED error message 16	3.4.3
SEKUND verification program (NORD-50)	app.c.3.1
SET ADDRESS button	2.2.4
SINGLE INSTRUCTION button	2.2.4
single processor (NORD-10)	1.3.1
SINTRAN III, loading	2.4.1
slave processor (NORD-50)	4.1
SPACE NOT AVAILABLE error message 28	3.4.3
start/restart procedure	3.3.3
starting a NORD-10	2.4.1
starting a program	2.3.1
STOP button	2.2.4
stopping a NORD-10	2.4.1
STS register button	2.2.9
system failure	3.3

T register button	2.2.9
TCOR-NGO verification program (NORD-50)	app.C.3.3
test programs (NORD-10)	3.6
test programs (NORD-50)	4.5, app.B
TEST-MEM program (NORD-50)	app.c.a
TMEM memory test program (NORD-50)	app.C.2
TOO BIG SEGMENT error message 19	3.4.3
TOO MANY FIXED PAGES error message 18	3.4.3
TRANSF!! error message	3.4.3
U button	2.2.9
verification programs (NORD-50)	app.C.3
X register button	2.2.9
! function (start a program)	2.3.1
\$ function (octal load)	2.3.2
& function (binary load)	2.3.2
* function (current location counter)	2.3.1
/ function (examine memory)	2.3.1
@ function (restart MOPC)	2.3.1





\*\*\*\*\* SEND US YOUR COMMENTS!!! \*\*\*\*\*



Are you frustrated because of unclear information in this manual? Do you have trouble finding things? Why don't you join the Reader's Club and send us a note? You will receive a membership card - and an answer to your comments.

Please let us know if you

- \* find errors
- \* cannot understand information
- \* cannot find information
- \* find needless information

Do you think we could improve the manual by rearranging the contents? You could also tell us if you like the manual!!



\*\*\*\*\* HELP YOURSELF BY HELPING US!! \*\*\*\*\*

Manual name: Nord-10/Nord-50 Operator's Guide

Manual number: ND-30.001.01

What problems do you have? (use extra pages if needed) \_\_\_\_\_

---



---



---



---



---



---



---



---



---



---

Do you have suggestions for improving this manual? \_\_\_\_\_

---



---



---



---



---



---



---



---



---



---

Your name: \_\_\_\_\_ Date: \_\_\_\_\_

Company: \_\_\_\_\_ Position: \_\_\_\_\_

Address: \_\_\_\_\_

---



---



---



---

What are you using this manual for? \_\_\_\_\_

Send to: Norsk Data A.S.  
Documentation Department  
P.O. Box 4, Lindeberg Gård  
Oslo 10, Norway



Norsk Data's answer will be found on reverse side

Answer from Norsk Data \_\_\_\_\_

\_\_\_\_\_  
\_\_\_\_\_  
\_\_\_\_\_  
\_\_\_\_\_  
\_\_\_\_\_  
\_\_\_\_\_  
\_\_\_\_\_  
\_\_\_\_\_  
\_\_\_\_\_  
\_\_\_\_\_  
\_\_\_\_\_  
\_\_\_\_\_  
\_\_\_\_\_  
\_\_\_\_\_  
\_\_\_\_\_  
\_\_\_\_\_  
\_\_\_\_\_  
\_\_\_\_\_  
\_\_\_\_\_

Answered by \_\_\_\_\_ Date \_\_\_\_\_



Norsk Data A.S.  
Documentation Department  
P.O. Box 4, Lindeberg Gård  
Oslo 10, Norway



# **The Competitive European Computer Company**

NORSK DATA A.S JERIKOVN. 20 P.O. BOX 4 LINDEBERG GÅRD OSLO 10 NORWAY  
TEL.: 02 - 30 90 30 - TELEX: 18661