

Norsk Data

Floppy Disk Controller

3027

ND-11.015.01

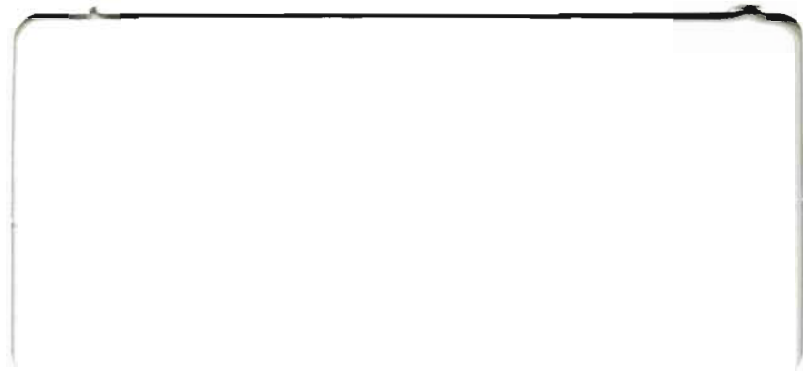

Floppy Disk Controller 3027

ND-11.015.01

NOTICE

The information in this document is subject to change without notice. Norsk Data A.S assumes no responsibility for any errors that may appear in this document. Norsk Data A.S assumes no responsibility for the use or reliability of its software on equipment that is not furnished or supported by Norsk Data A.S.

The information described in this document is protected by copyright. It may not be photocopied, reproduced or translated without the prior consent of Norsk Data A.S.

Copyright © 1981 by Norsk Data A.S.

This manual is in loose-leaf form for ease of updating. Old pages may be removed and new pages easily inserted if the manual is revised.

The loose leaf form also allows you to place the manual in a ring binder (A) for greater protection and convenience of use. Ring binders with 4 rings corresponding to the holes in the manual may be ordered in two widths, 30 mm and 40 mm. Use the order form below.

The manual may also be placed in a plastic cover (B). This cover is more suitable for manuals of less than 100 pages than for large manuals. Plastic covers may also be ordered below.

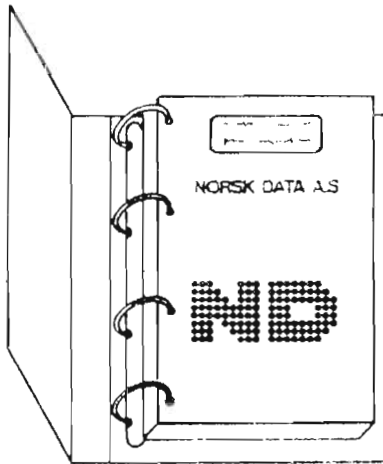

A. Ring Binder

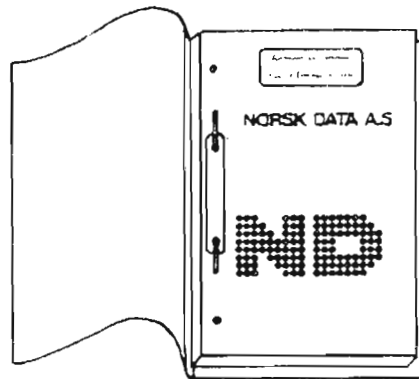

B. Plastic Cover

Please send your order to the local ND office or (in Norway) to:

Norsk Data A.S
Graphic Center
P.O. Box 25, Bogerud
0621 Oslo 6, Norway

ORDER FORM

I would like to order

..... Ring Binders, 30 mm, at nkr 20,- per binder

..... Ring Binders, 40 mm, at nkr 25,- per binder

..... Plastic Covers at nkr 10,- per cover

Name

Company

Address

City

Manuals can be updated in two ways, new versions and revisions. New versions consist of a complete new manual which replaces the old manual. New versions incorporate all revisions since the previous version. Revisions consist of one or more single pages to be merged into the manual by the user, each revised page being listed on the new printing record sent out with the revision. The old printing record should be replaced by the new one.

New versions and revisions are announced in the ND Bulletin and can be ordered as described below.

The reader's comments form at the back of this manual can be used both to report errors in the manual and to give an evaluation of the manual. Both detailed and general comments are welcome.

These forms and comments should be sent to:

Documentation Department
Norsk Data A.S
P.O. Box 25, Bogerud
0621 Oslo 6, Norway

Requests for documentation should be sent to the local ND office or (in Norway) to:

Graphic Center
Norsk Data A.S
P.O. Box 25, Bogerud
0621 Oslo 6, Norway

THE MANUAL

This manual gives a general description of the Floppy Disk Controller -3027. It contains general information on the hardware and the self test feature and explains the read write operations and their associated commands.

THE READER

The manual is written for service personnel and also those who intend to write their own driver routines.

PREREQUISITE KNOWLEDGE

The reader should know the FLOPPY DISK SYSTEM manual (ND.-11.012.01) and the TEST PROGRAM DESCRIPTION (ND-30.005).

T A B L E O F C O N T E N T S

<u>Section</u>	<u>Page</u>
1. INTRODUCTION	1
1.1. GENERAL DESCRIPTION	1
2. NORMAL OPERATION	3
2.1. READ/WRITE OPERATIONS	3
3. HARDWARE	5
3.1. STANDARD HARDWARE	5
4. TESTING	7
4.1. SELF-TESTING	7
4.2. RAMTEST	7
4.3. TEST OPTIONS	8
5. COMMANDS	9
5.1. READ DATA	9
5.2. WRITE DATA	9
5.3. FIND EOF	9
5.4. WRITE EOF	9
5.5. FORMAT FLOPPY	10
5.6. READ FORMAT	10

Section	Page
5.7. READ DELETED RECORD	10
5.8. WRITE DELETED RECORD	10
5.9. COPY FLOPPY	10
5.10. FORMAT TRACK	11
5.11. CHECK FLOPPY	11
6. PROGRAMMING SPECIFICATIONS	13
6.1. IOX-NUMBERS	13
6.2. THUMBWHEEL SETTINGS	13
6.3. COMMAND ADDRESS BLOCK & STATUS BLOCK	14
6.4. STATUS WORD 1 - 3027B	15
6.5. STATUS WORD 2 - 3027B	15
6.6. HARDWARE - CONTROL WORD	16
6.7. HARDWARE - STATUS WORD	16
6.8. COMMAND WORD	17
6.9. ERRORCODES	19
7. TEST MACROS	21
7.1. HARD CONTROLWORD FOR TEST	21
7.2. TEST ROUTINES IN THE FLOPPY CONTROLLER	21
7.3. ADDRESS FIELD FOR UP DOWN LOAD	23
7.4. READING THE MICRO-PROGRAM VERSION NUMBER	24
8. REGISTERS IN THE FLOPPY CONTROLLER	25
8.1. RWFF - REGISTER	26

Section	Page
8.2. FINI - SET RPT AND STATUS	26
8.3. TRST - TRANSFER STATUS REGISTER	27
8.4. SDISP - SET DATA TO DISPLAY	27
8.5. DMREG - DISPLAY AND MODE REGISTER	28
8.6. FDVSEL - DEVICE SELECT AND MODE REGISTER	28
8.7. FCCLR - REGISTER	28
8.8. FDST - FLOPPY DRIVE STATUS	29
8.9. CW - REGISTER	29
8.10. FLAGREGISTERS IN FDTFI	30
8.11. FLOPPY - DATAFIELD	31
8.12. MEMORY ORGANISATION -3027	33
8.13. ND-100 DOUBLE DENSITY FLOPPY FORMAT	35
8.14. ONE-SHOTS AND RC-DELAYS ON THE FLOPPY DISK CONTROLLER	36

APPENDICES

APPENDIX A	MICROPROGRAM FOR FLOPPY DISK CONTROLLER	39
------------	---	----

LIST OF FIGURES

FIGURE 1.	3027 FLOPPY DISK CONTROLLER	2
FIGURE 2.	REGISTERS AND BUSES IN THE ND-100 INTERFACE	37

1. INTRODUCTION

1.1. GENERAL DESCRIPTION

The FLOPPY DISK CONTROLLER -3027 can read/write on single/double density and single/double-sided diskettes. Data transfer and exchanging of commands/status is done with DMA (Direct Memory Access).

The controller is designed and built around the Z80A-microprocessor, the AM9517 DMA controller and the FD1797 floppy disk controller.

The controller is compatible with previous single-sided controllers. For "stand-alone" use, a new version of FLO-MON (FLOPPY-MONITOR-2010F) must be dumped on the diskette.

Possibilities of simulating DMA-loads are implemented, but due to the micro program in the ND-100, this can only be performed from terminal (21560\$) (DMA-load), and not by setting the ALD selector on the CPU module.

When DMA-load is performed, "the first page" on floppy is dumped to "first page" on the ND-100. It is also possible to "load" BPUN-files of maximum 64k words directly from from the floppy by pressing LOAD.

There is a new driver program in the ND-100 which is smaller than those used in previous floppy controllers.

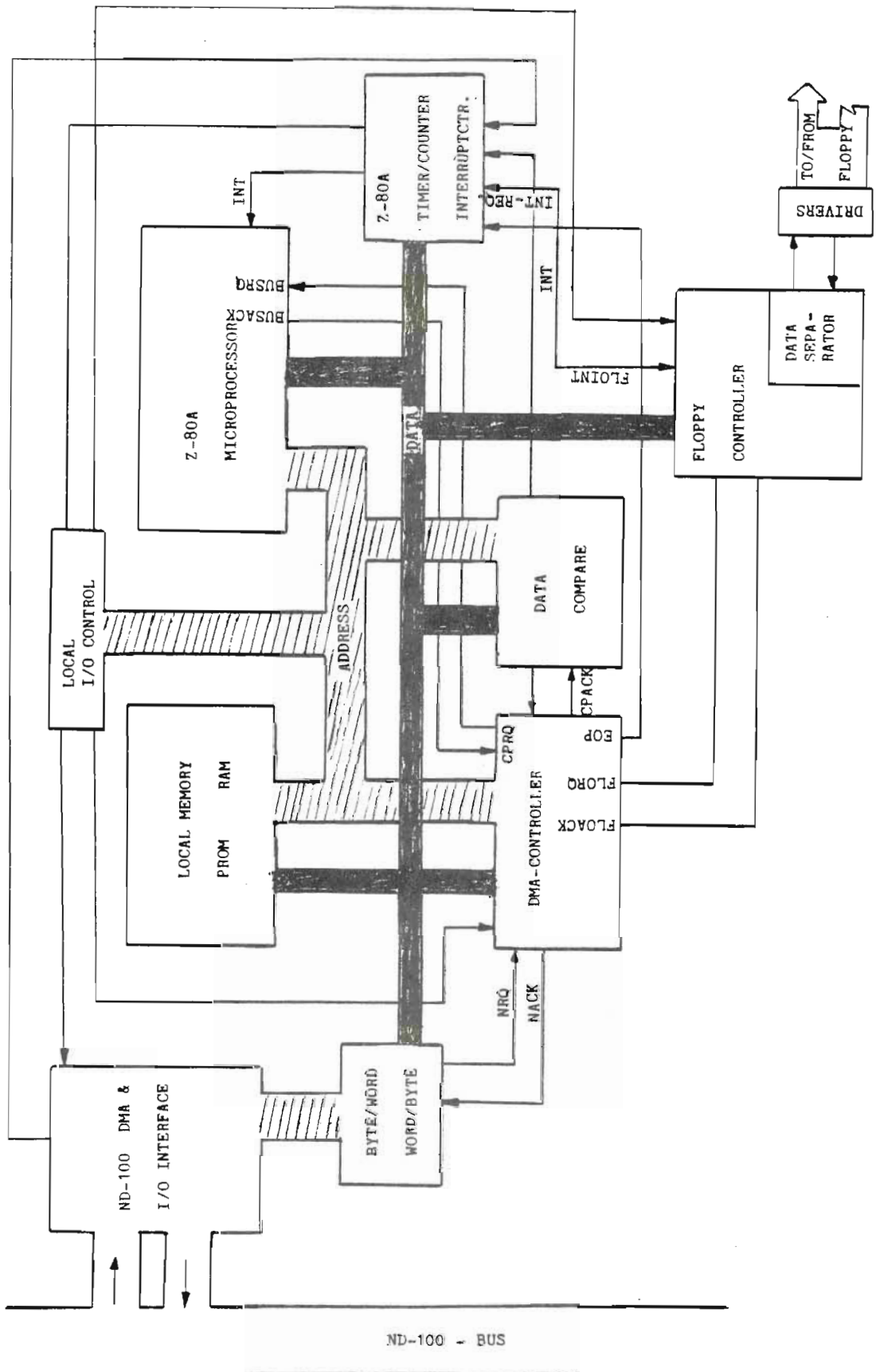

Figure 1. 3027 Floppy Disk Controller.

ND-11.015.01

2.NORMAL OPERATION

2.1.READ/WRITE OPERATIONS

When activating for read/write operations follow these steps:

- 1) Enter command block to the ND-100 memory. (Consisting of 6 words - command - diskaddress - DMA address - Word count/number of sectors.) (See also programming example.)
- 2) Load command-block pointers to the controller by means of IOX. (IOX DEVNO+5 , IOX DEVNO+7 .)
- 3) Activate controller by loading the control word with bit 8 set. (IOX DEVNO+3 .)

When the control word is loaded, an interrupt is given to the Z80 processor. A DMA transfer of the command block from the ND-100 to the floppy controllers local memory is initiated. The command is analyzed and executed.

When data transfer has terminated, the status block of 6 words (16 bits) is transferred to ND-100 and placed in memory after the command block.

Finally the "READY-FOR-TRANSFER" signal is set which also gives an interrupt to ND-100 (if interrupt is enabled).

3.HARDWARE

3.1.STANDARD HARDWARE

The controller is equipped with standard IOX and DMA logic. IOX numbers can be found in the programming examples.

It is possible to choose between the device numbers 1560 and 1570. They are represented by 0 and 1 respectively on the thumb wheel.

Converting 16-bit words to bytes is done during the DMA transfer of a sequence made up of a PAL10L8 (which is of PROM-type) and two flip-flops. Internally this module has an eight bit bus. Normally, there will be 6 kbyte PROMs and 4 kbyte RAMs, both of which can be extended easily to 8 kbytes by adding more circuits.

A CMOS counter controls the time-out function. It is set when loading the control word and reset each time data is transmitted between the floppy drive and the controller. Time-out after approximately 10 seconds.

A new feature added on this controller is a hardware compare circuit which verifies data read from or written to the diskette.

The control part of the floppy is taken care of mainly by FD1797 circuits delivered by Western Digital. This circuit does most of the control functions. The synchronizing and separating of data and clock, however, must be done outside this circuitry in a data separator.

The data separator consists of an analog phase locked loop, and some circuitry to compensate for loss of time margin in the floppy control circuit.

Precompensation is done outside FD1797 and may be turned ON/OFF from the processor.

Error codes are shown on a display at the edge of this module. The codes shown are the same as the codes returned in statusword 1 (bit 9-15).

4. TESTING

4.1. SELF-TESTING

When an MC (MASTER CLEAR) pulse is given to the floppy controller the processor will perform a self-test. This can be observed on the error display which is first "turned OFF", then set to 000 upon successful completion of the test. During selftest, drive 0 is selected and restored.

Upon detection of errors the codes E70-E75 are displayed. If the display is not lit or shows codes other than the ones specified, the processor will not be able to perform a selftest.

The phases of the selftest are as follows:

1. The proms are read and a checksum is calculated. This checksum should be equal to 55H (H = hexadecimal).
2. A RAM test is performed.
3. The Z80A-CTC (timer/interrupt controller) is tested.
4. The DMA-controller AM9517-4 is run in testmode.
5. The VCO SN74LS629 is measured and adjusted to be within the limits of the phaselocked loop.
6. A test of the floppy controller chip FD1797.

4.2. RAMTEST

The part of the RAM being used for buffering of data from/to the floppy disk will be tested continuously. The test starts when the controller has been idle for approximately 3 minutes.

This is a comprehensive test that uses approximately 30 minutes to test 1Kbyte.

A new access from the ND-100 will stop the test.

NOTE: If errors are discovered during selftest or RAM test the controller will not carry out commands. This to prevent destruction of data on the diskettes.

Bit 4 and 7 in the status word (hardware) will be set. The status field will not be written to the ND-100 memory. The status word 1, however, will be written to the controller data register and may be read from this (IOX DEVNO.+0).

4.3.TEST OPTIONS

A total of 24 different tests are supported by the microprocessor program (see specification).

This should make it easy to write test and maintenance programs.

As an example, the T13 makes it possible to write a Z80 program, load it from ND-100 to the local RAM and start program execution by T15.

T7 -T8 -T24 makes it possible to read and write to all registers in the controller.

5.COMMANDS

5.1.READ DATA

Data is read from the floppy disk to the ND-100 memory. The start address is given as the logical sector address, and a choice can be made between the wordcount and the number of sectors to indicate the length of the transfer.

NOTE: The transfer will always start at the beginning of a sector, but the number of words to be read may be preset to any number of words.

5.2.WRITE DATA

Same procedure as READ DATA, except that transfer is now from ND-100 to the diskette.

5.3.FIND EOF

Same procedure as READ DATA, except that data is only read to the local buffer. There is no transfer to ND-100, except for the status. Bit 5 in status word 1 indicates if it is an EOF (deleted record).

5.4.WRITE EOF

The sector given in the command block is read to the local memory and written back as a deleted record.

5.5.FORMAT FLOPPY

The floppy disk placed in the specified drive is formatted to the format given in the command word.

5.6.READ FORMAT

The format is read from the floppy disk and returned to status word two. The disk address and the format of the command field indicates where the format should be read.

5.7.READ DELETED RECORD

Reads data from a record marked as a deleted record, and transfers them to ND-100.

5.8.WRITE DELETED RECORD

Writes a record from ND-100 and marks it as a deleted record.

5.9.COPY FLOPPY

Copies from one drive to another. The entire floppy is copied.

5.10.FORMAT TRACK

One track on one side is formatted. This command can be used to make IBM compatible diskettes.

NOTE: The track address must be given as logical address to the first sector of the track.

5.11.CHECK FLOPPY

Data is read to the controllers local memory to test for CRC-errors. The test halts with the first discovered error. The address of the erroneous sector is held in LAST MEMADR. in the status field.

STATUS FIELD:

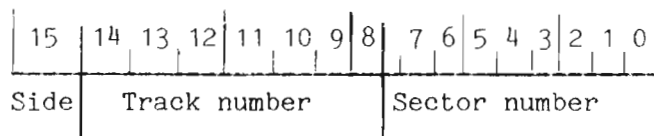

6.PROGRAMMING SPECIFICATIONS

6.1.IOX-NUMBERS

DEVNO + 0	- READ DATA
DEVNO + 1	- NOT USED
DEVNO + 2	- READ STATUS
DEVNO + 3	- LOAD CONTROL WORD
DEVNO + 4	- READ STATUS
DEVNO + 5	- LOAD POINTER HIGH (BIT 16-23)
DEVNO + 6	- NOT USED
DEVNO + 7	- LOAD POINTER LOW/LOAD DATA

6.2.THUMBWHEEL SETTINGS

0	-	DEVNO	1560
1	-	DEVNO	1570
2-15	-	NOT USED	

6.3.COMMAND ADDRESS BLOCK & STATUS BLOCK

	15	8	7	0	
	COMMAND		WORD		0 1
	DISK		ADDRESS		2 3
	NOT USED		MEMADDR HI-BYTE (BIT 23-16)		4 5
	MEMORY (15-8)		ADDRESS (7-0)		6 7
WC/SC	15 NOT USED		WORD CNT. HI (8 BIT)		8 9
	WORD COUNT/SECT COUNT (16 BIT)				A B
	STATUS 1				C D
	STATUS 2				E F
			LAST ADDR (HI)		10 11
	LAST MEM.ADDRESS.				12 13
			RE. WORDS (HI)		14 15
	REMAINING WORDS				16 17

POINTS TO NOTE:

IF WC/SC - 1. - WORDCOUNT
IF " 0. - SECTORCOUNT

DISK ADDRESS: INDICATES THE START ADDRESS ON THE FLOPPY DISK. THIS IS GIVEN AS A LOGICAL SECTOR ADDRESS, STARTING WITH TRACK 00, SIDE 0, SECTOR 1 WHICH IS ADDRESS 0 AND INCREASING TO THE MAXIMUM NUMBER OF SECTORS.

MEM. ADDRESS: INDICATES WHERE TO START IN THE ND-100 MEMORY.

WORD/SECT COUNT: WC/SC = 1 INDICATING WORD COUNT (=24 BIT)
WC/SC = 0 INDICATING SECTOR COUNT (NUMBER OF SECTORS TO BE TRANSFERRED).
IF THE WORD COUNT IS LESS THAN THE NUMBER OF WORDS IN A SECTOR,
THE TRANSFER WILL START AT THE BEGINNING OF THE SECTOR.

ND-DUAL-DENSITY-FORMAT = 8 (SECT) X 77 (TRACKS) X 2 (SIDES)

6.4.STATUS WORD 1 - 3027B

BIT		
0	RFT - INTERRUPT ENABLED	
1	NOT USED	
2	DEVICE ACTIVE	SAME AS HARDWARE-STATUS WORD
3	DEVICE READY FOR TRANSFER	
4	OR OF ERRORS	
5	DELETED RECORD	
6	RETRY ON CONTROLLER	
7		
8	NOT USED	
9	} ERROR CODE FROM CONTROLLER (LISTED IN SECTION 4.4.20)	
10		
11		
12		
13		
14		
15		

6.5.STATUS WORD 2 - 3027B

BIT			
0	} BYTES / SECTOR	FORMAT READ FROM DISKETTE VALID FOR READ FORMAT COMMAND OR WHEN ERROR 12	
1			
2			DOUBLE SIDED
3			DOUBLE DENSITY
4			NOT USED
5			NOT USED
6			NOT USED
7	NOT USED		
8	SELECTED UNIT		
9	SELECTED UNIT		
10	NOT USED		
11	NOT USED		
12	NOT USED		
13	NOT USED		
14	NOT USED		
15	NOT USED		

6.6.HARDWARE - CONTROL WORD

IOX (DEVNO. + 3)

BIT		
0	NOT USED	
1	ENABLE INTERRUPT ON RFT	
2	ACTIVATE AUTOLOAD	
3	TEST MODE	
4	DEVICE CLEAR	
5	NOT USED	
6	NOT USED	
7	NOT USED	
8	EXECUTE COMMAND	
9	IF BIT 8=1 : STEP RATE	IF BIT 3=1
10	AND BIT 3=0: IN USE	THEN BIT
11	: DISABLE PRECOMP	BIT 9-13 ARE
12	: 96 TPI (144 TRACK)	TESTSPECS
13	: COMPARE	
14	NOT USED	
15	NOT USED	

6.7.HARDWARE - STATUS WORD

IOX (DEVNO + 2)

BIT	
0	NOT USED
1	RFT - INTERRUPT ENABLED
2	DEVICE ACTIVE
3	DEVICE READY FOR TRANSFER
4	OR OF ERRORS
5	NOT USED
6	NOT USED
7	HARDERROR - DMA TRANSFER
8	
9	
10	
11	} NOT USED
12	
13	
14	
15	1- HIGH=DUAL DENSITY CONTROLLER

6.8.COMMAND WORD

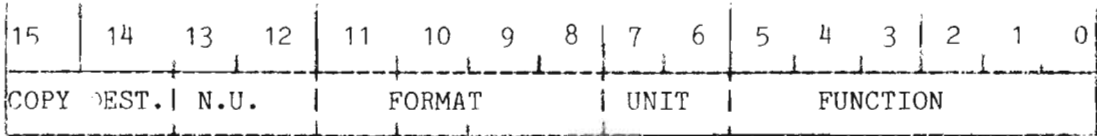

D S
 E I
 N D
 S E
 I
 T
 Y

BIT 0-5:	OCTAL	HEXA	FUNCTION
	0	0	READ DATA
	1	1	WRITE DATA
	2	2	FIND EOF (READ WITHOUT DATATRANSFER)
	5	5	WRITE EOF (WRITE DELETED RECORD)
	41	21	FORMAT FLOPPY
	42	22	READ FORMAT
	43	23	READ DELETED RECORD
	44	24	WRITE DELETED RECORD
	54	2C	COPY FLOPPY
	55	2D	FORMAT TRACK
	56	2E	CHECK FLOPPY
BIT 6-7:	0	0	SELECT UNIT 0
	1	1	SELECT UNIT 1
	2	2	SELECT UNIT 2
	3	3	SELECT UNIT 3
BIT 8-11:			FORMAT

BIT:	9	8	
	0	0	512 BYTES/SECTOR
	0	1	256 BYTES/SECTOR
	1	0	123 BYTES/SECTOR
	1	1	1024 BYTES/SECTOR

BIT:	10	
	0	SINGLE SIDED
	1	DOUBLE SIDED

BIT:	11	
	0	SINGLE DENSITY
	1	DOUBLE DENSITY

BIT: 12-13 NOT USED

BIT: 14-15 COPY DESTINATION

6.9.ERRORCODES

OCTAL	
00	OK
05	CRC ERROR
06	SECTOR NOT FOUND
07	TRACK NOT FOUND
10	FORMAT NOT FOUND
11	DISKETTE DEFECT (IMPOSSIBLE TO FORMAT)
12	FORMAT MISMATCH
13	ILLEGAL FORMAT SPECIFIED
14	SINGLE SIDED DISKETTE INSERTED
15	DOUBLE SIDED DISKETTE INSERTED
16	WRITE PROTECTED DISKETTE
17	DELETED RECORD
20	DRIVE NOT READY
21	CONTROLLER BUSY ON START
22	LOST DATA (OVER OR UNDERRUN)
23	TRACK ZERO NOT DETECTED
24	VCO FREQUENCY OUT OF RANGE
25	MICROPROGRAM OUT OF RANGE
26	TIMEOUT
27	UNDEFINED ERROR
30	TRACK OUT OF RANGE
31	
32	COMPARE ERROR (DURING COMPARE OF DATA)
33	INTERNAL DMA ERRORS
34	
35	
36	
37	

40	ND-100 BUS ERROR COMMAND FETCH	
41	ND-100 BUS ERROR STATUS TRANSFER	
42	ND-100 BUS ERROR DATA TRANSFER	
43	ILLEGAL COMMAND	
44	WORDCOUNT NOT ZERO	
45		
46		
47		
50	NO BOOTSTRAP FOUND ON DISKETTE	
51	WRONG BOOTSTRAP (TOO OLD FLO-MON VERSION)	
52		
53		
54		
55		
56		
57		
60		
61		
62		
63		
64		
65		
66		
67		
70	PROM CHECKSUM ERROR	
71	RAM ERROR	
72	CTC ERROR	
73	DMACTRL ERROR	SELFTEST ERROR
74	VCO ERROR	
75	FLOPPY CONTROLLER ERROR	
76		
77		

7.TEST MACROS

7.1.HARDWARE CONTROLWORD IN TESTMODE

The floppy controller has a program containing various test routines. These routines can be activated from the ND-100. It is done by setting bit 3 in the control word. This indicates that bits 9-15 have a special meaning. They will contain the number of the test to be activated.

The significance of the contents of registers POH, POM and POL will vary with the different tests. However, it will normally be these registers that are used to transfer parameters used in the testing. This avoids using the COMMAND FIELD in memory.

The tests T13 and T14 are exceptions. They use a field in the ND-100 memory to specify addresses and bytecount when loading program/data to/from the ND-100.

The tests T13, T14, T16, T17 and T18 will write the status word 1 to the data out register. This register can be read with the IOX READ-DATA.

7.2.TEST ROUTINES IN THE FLOPPY CONTROLLER

BITS 0 - 8 STANDARD (WHEN TEST BIT 3 IS SET) BITS 9 - 15 SPECIFY TEST
--

The tests and the control words are given on the following page.

TEST	CONTROLWORD	ACTION
T0	00041X	DO NOTHING (SET RFT)
T1	00141X	STOP CONTROLLER (TEST TIMEOUT)
T2	00241X	DATA INPUT REGS. (POL & POM) ARE COPIED TO DATAOUT REGISTERS (DLO & DHI).
T3	00341X	DOH IS COPIED TO DLO (BITS 0-7)
T4	00441X	POH IS COPIED TO ADDRESS GIVEN BY POL & POM
T5	00541X	DLO-REG IS LOADED WITH BYTE ADDRESSED BY POL & POM
T6	00641X	MEM. SIZE (UPPER ADDRESS IN RAM) LOADED TO POL & POM
T7	00741X	POM IS WRITTEN TO REGISTER ADDRESSED BY POL
T8	01041X	DLO LOADED WITH CONTENTS OF REG. ADDRESSED BY POL
T9	01141X	DMA INPUT TEST (Z80→ND-100) POH = BLOCK NUMBER IN Z80 MEMORY BLOCK 1 STARTS AT 2000H IN CONTROLLER POL & POM = ND-100 ADDRESS (ONLY FIRST 64K WORDS ARE USED) Z80 ADDR. = 2000H + [128 · (POH - 1)]
T10	01241X	DMA OUTPUT TEST (ND-100-Z80) PARAMETER SAME AS T9
T11	01341X	COMPARE TEST POL & POM = START ADDRESS COMPARE IN THE Z80 MEMORY THE TWO FOLLOWING BLOCKS OF 128 BYTES. DLO & DHI = REMAINING BYTES AFTER COMPARE ERROR IF DLO & DHI = 0 THEN OK
T12	01441X	DISPLAY TEST. DISPLAY COUNT FROM 0 TO 9
T13	01541X	LOAD TO Z80 FROM ND-100 ADDRESS IN ND-100 AND Z80, WORDCOUNT IS FETCHED FROM ND-100 MEMORY POH, POM & POL ARE POINTERS TO PARAMETER FIELD (SEE ALSO NEXT PAGE FOR THIS TEST)
T14	01641X	LOAD TO ND-100 FROM Z80 (PARAMETER SAME AS T13)
T15	01741X	START PROGRAM IN ADDRESS GIVEN BY POL & POM
T16	02041X	GENERATE CRC ERROR ON; POL = SECTOR NUMBER, POL = TRACK, POH = DEVICE-SEL-REG. (FDVSEL)
T17	02141X	DESTROY TRACK; POM = TRACK, POH = DEV-SEL-REG.
T18	02241X	DESTROY 1 SECTOR POM = TRACK, POH = DEV-SEL-REG.
T19	02341X	TAP-TAP TEST. POH = NUMBER OF TAPS.
T20	02441X	STOP DISPLAY
T21	02541X	CHANGE TO INTERRUPT ADDRESS IN PROM (FOR RAM TEST).
T22	02641X	LOAD STACKPOINTER (POL & POM = VALUE)
T23	02741X	READ STACKPOINTER
T24	03041X	EXECUTE FD1797 COMMAND POH = FD1797 TRACK REGISTER POL = FD1797 COMMAND REGISTER WHEN FINISHED: POM = FD1797 TRACK-REG POL = FD1797-STATUS

NOTE: IF X = 0, NO INTERRUPT - IF X = 1 INTERRUPT WHEN FINISHED

7.3.ADDRESS FIELD FOR UP DOWN LOAD

(USED FOR T13 AND T14)

IN Z80 RAM:

20F2H	ND-100 LOAD ADDR
20F1H	ND-100 LOAD ADDR
20F2H	Z80 ADDR
20F3H	Z80 ADDR
20F4H	BYTECOUNT
20F5H	BYTECOUNT

8 BITS

IN ND-100:

ADDRESS-FIELD	ND-100 LOAD ADDRESS
+ 1	Z80 ADDRESS
+ 2	BYTECOUNT

16 BITS

POL, POM AND POH POINTS TO ADDRESS-FIELD

7.4.READING THE MICRO-PROGRAM VERSION NUMBER

When the microprogram is changed it will be given a new version number. This is done by adding a letter (A-Z) after the PROM number.

The PROM will also contain a counter that will keep track of the version and this counter can be read by running test 5 (T5).

The PROM number, contained in address 60H, is given as 0, 1, 2.....,where A=0, B=1, C=2 and so on. The version may be read as follows (ND-100 program):

```

SAA      140      % Address 60H in
IOX      DEVNO+7  % Z80 Memory
LDA      (5410    % Test number 5
IOX      DEVNO+3
IOX      DEVNO+2  % Wait until
BSKP     ZRO 20 DA % ready
JMP      *-2
IOX      DEVNO+0
WAIT
)FILL    % A-register contains
          % when micro program
          % version number

```

8. REGISTERS IN THE FLOPPY CONTROLLER

Description of the various registers in the DMA controller AM9517, the floppy controller FD1797, the counter-timer Z80-CTC and the digital/analog converter AD558 can be found in the respective databooks.

NAME	REGISTER FUNCTION	VALUE (HEX)	VALUE (OCT)
CNB	CTC-CHNL 0: INT: FROM ND-100	10	20
CCP	CTC-CHNL 1: INT: FROM HARD-COMPARE	11	21
CFC	CTC-CHNL 2: INT: FROM FLOPPY-CONTR	12	22
CDMA	CTC-CHNL 3: INT: FROM DMA-CONTR	13	23

DMA CONTROLLER

DCOM	COMMAND REGISTER	28	50
DMOD	MODE REGISTER	2B	53
DRQ	REQUEST REGISTER	29	51
DMSK	MASK REGISTER (WRITE BIT)	2A	52
DMSKW	MASK REGISTER (WRITE ALL BITS)	2F	57
DTEMP	TEMPORARY REGISTER	2D	55
DST	STATUS REGISTER	28	50
DMC	MASTER CLEAR (PROGRAMMED)	2D	55
DCFF	CLEAR INTERNAL FLIP-FLOP	2C	54
DADR	ADDRESS REGISTER CHANNEL 0	20	40
DWC	WORD COUNT CHANNEL 0	21	41

ND-100 BUSCONTROL

ADL	DMA ADDRESS BITS 0-7	50	120
ADM	DMA ADDRESS BITS 8-15	51	121
ADH	DMA ADDRESS BITS 16-23	52	122
RWFF	READ OR WRITE DMA	53	123
DLO	DATA OUT BITS 0-7	54	124
DHI	DATA OUT BITS 8-15	55	125
SDISP	DATA TO DISPLAY (7 SEG)	56	126
FINI	SET RFT AND STATUS (FINISH)	57	127
TRST	TRANSFER STATUS REGISTER (DMA)		50
	120		
POL	POINTER OR DATA-IN BIT 0-7	51	121
POM	POINTER OR DATA-IN BIT 8-15	52	122
POH	POINTER ADDRESS BITS 16-23	53	123
CW	CONTROLWORD	54	124

FLOPPY CONTROLLER

FCCOM	COMMAND REGISTER	70	160
FCST	STATUS	70	160
FCTRK	TRACK	71	161
FCSEC	SECTOR	72	162
FCDAT	DATA	73	163
FDVSEL	DEVICE SELECT AND MODE	74	164
FCCLR	FLOPPY CONTROLLER CLEAR	75	165
FADC	DIGITAL/ANALOG CONVERTER	76	166
FDST	FLOPPY DRIVE STATUS	77	167
DMREG	DISPLAY AND MODE REGISTER	40	100

8.1.RWFF - REGISTERDMA DIRECTION

BIT 0 : 0 DMA TO ND-100
 " : 1 DMA FROM ND-100
 BIT 1-7 : NOT USED

8.2.FINI - SET RFT AND STATUS

BIT 0 : OR OF ERRORS (BIT 4 IN HARDWARE STATUS WORD)
 " 1 : HARDERROR (BIT 7 IN HARDWARE STATUS WORD)
 BIT 2-7 : NOT USED

NOTE: RFT IS ALWAYS SET WHEN WRITING TO THIS REGISTER.

8.3.TRST - TRANSFER STATUS REGISTER

- BIT 0 - DMA TRANSFER FINISHED WHEN ZERO
(ONE WORD FINISHED)
- " 1 - ERROR ON LAST TRANSFER IF SET TO ONE
- 2-7 - TIED LOW

NOTE: THIS REGISTER SHOULD BE ZERO AFTER A SUCCESSFUL
DMA TRANSFER.

8.4.SDISP - SET DATA TO DISPLAY

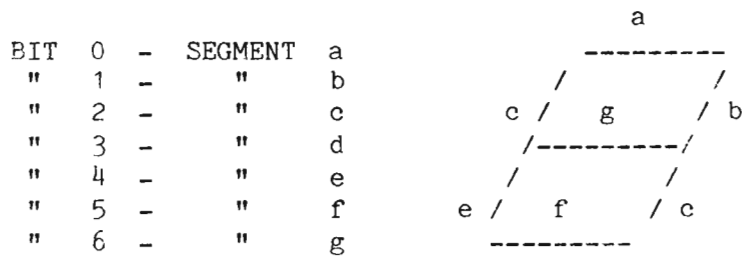

THE DISPLAY CONTAINS 3 NUMBERS. THE NUMBER TO BE LIT IS
SELECTED BY LOADING DMREG.

8.5.DMREG - DISPLAY AND MODE REGISTER

BIT	0-2	NOT USED
"	3	PRECOMPENSATION (0=OFF, 1=ON)
"	4	NOT USED
"	5	SELECT FIRST NUMBER IN DISPLAY
"	6	" SECOND NUMBER IN DISPLAY
"	7	" THIRD NUMBER IN DISPLAY

8.6.FDVSEL - DEVICE SELECT AND MODE REGISTER

BIT	0	-	SELECT DRIVE 0
"	1	-	" 1
"	2	-	" 2
"	3	-	" 3
"	4	-	SELECT DENSITY (DUAL=0, SINGLE=1)
"	5	-	ENABLE COMPARE CIRCUIT
"	6	-	ENABLE VCO ADJUSTMENT
"	7	-	SET IN-USE-LINE

8.7.FCCLR - REGISTER

USED TO PRODUCE A CLEAR PULSE FOR THE FD1797, NO DATA REQUIRED.

8.8.FDST - FLOPPY DRIVE STATUS

READ THE STATUSLINES FROM THE SELECTED DRIVE;

BIT 0 - READY
" 1 - DOUBLESIDED DISKETTE
" 2 - DISK CHANGED WHILE SELECTED
" 3 - ON TRACK 00
" 4-7 - NOT USED

ALL BITS ARE TRUE WHEN ZERO

8.9.CW - REGISTER

HARDWARE CONTROL WORD TRANSFORMED AND READ INTO Z80.

BIT 0 - LOAD FLOMON TO ND-100
" 1 - GET COMMAND FROM ND-100
" 2 - TEST MODE
" 3 - STEP RATE
" 4 - IN USE
" 5 - DISABLE PRECOMPENSATION
" 6 - 96 TPI (144 TRACK)
" 7 - COMPARE

BIT 3
" 4
" 5 - TEST SPECIFICATIONS IF BIT 2=1
" 6 - NOT USED IF BIT 0=1

8.10.FLAGREGISTERS IN FDTFI

FLOFLG: (IX+0EH)

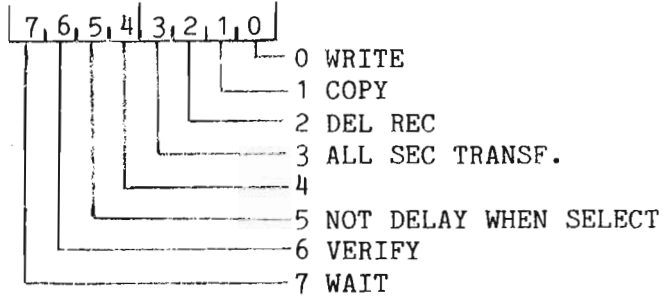

LFLAG: (IX+0DH)

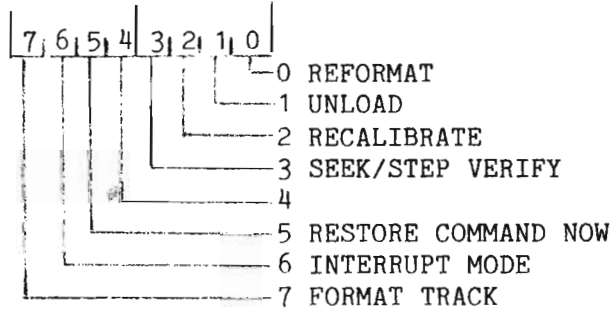

ERRFLG: (IX+IDH)

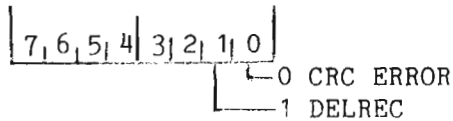

8.11.FLOPPY - DATAFIELD

	-2	NOROT	NUMBER OF ROTATIONS BEFORE LAST DESELECT
	-1	LSEL	LAST DEVICE SELECT
FDTFI:	0	TRRG 0	TRACK REGISTER DRIVE 0
	1	TRRG 1	1
	2	TRRG 2	2
	3	TRRG 3	3
	4	SDEV	SOURCE DEVICE
	5	SDVSEL	SOURCE DEVICE SELECT REGISTER
	6	DEV	CURRENT DEVICE (CODED)
	7	DVSEL	CURRENT DEVICE SELECT REGISTER
	8	LTRACK	LAST TRACK
	9	LSIDE	LAST SIDE
	A	LSECT	LAST SECTOR
	B	LCOM	LAST COMMAND ISSUED
	C	LSTAT	LAST STATUS READ
	D	LFLAG	LOCAL-FLAGS USED BY FLODR
	E	FLOFLG	FLOPPY FLAG REGISTER
	F	GRETR	GENERAL RETRY COUNTER
	10	FORMCO	FORMAT FROM COMMAND
	11	FORMRD	FORMAT READ FROM FLOPPY
	12	SELLEN	SECTOR LENGTH CODE
	13	SECTR	NUMBER OF SECTORS/TRACK
BYTSEC:	14	LOBYTSEC	NUMBER OF BYTES/SECTOR
	15	HIBYTSEC	NUMBER OF BYTES/SECTOR
	16		
	17		
	18	NFORRD	READ FORMAT IN
	19		ND-100 CODE

FLOPPY DISK CONTROLLER -3027
REGISTERS IN THE FLOPPY CONTROLLER

	1A	FSTEP	STEPPING RATE	
	1B			
	1C			
	1D	ERRFLG	FLAGGING VARIOUS ERRORS	
	1E	RRETRY	RESTORE RETRY	
	1F	STPCT	STEP-IN COUNTER	
	20	NXRD	NEXT BUFFER TO BE READ	
	21	NXWR	NEXT BUFFER TO BE WRITTEN	
	22	BUFFUL	NUMBER OF BUFFERS FULL	
	23	DFLAG	DMA FLAG	
	24	DRETRY	RETRYCOUNTER DMA	
	25	BUFNO	NUMBER OF BUFFERS (RAM)	
NOSEC	26	LNOSECT	NUMBER OF SECTORS TO	
	27	HNOSECT	BE TRANSFERRED	
REMSEC	28	REMSEC	REMAINING SECTORS	
	29			
	2A			
	2B			
	2C			
	2D			
	2E			
	2F			
	2130	DDEV	DESTINATION DEVICE (COPY)	
	2131	DDVSEL	DEVICE SELECT REGISTER	
	2132	DTRACK	DESTINATION TRACK	COPY
	2133	DSIDE	DESTINATION SIDE	
	2134	DSECT	DESTINATION SECTOR	

8.12.MEMORY ORGANISATION -3027

(H = HEXADECIMAL)

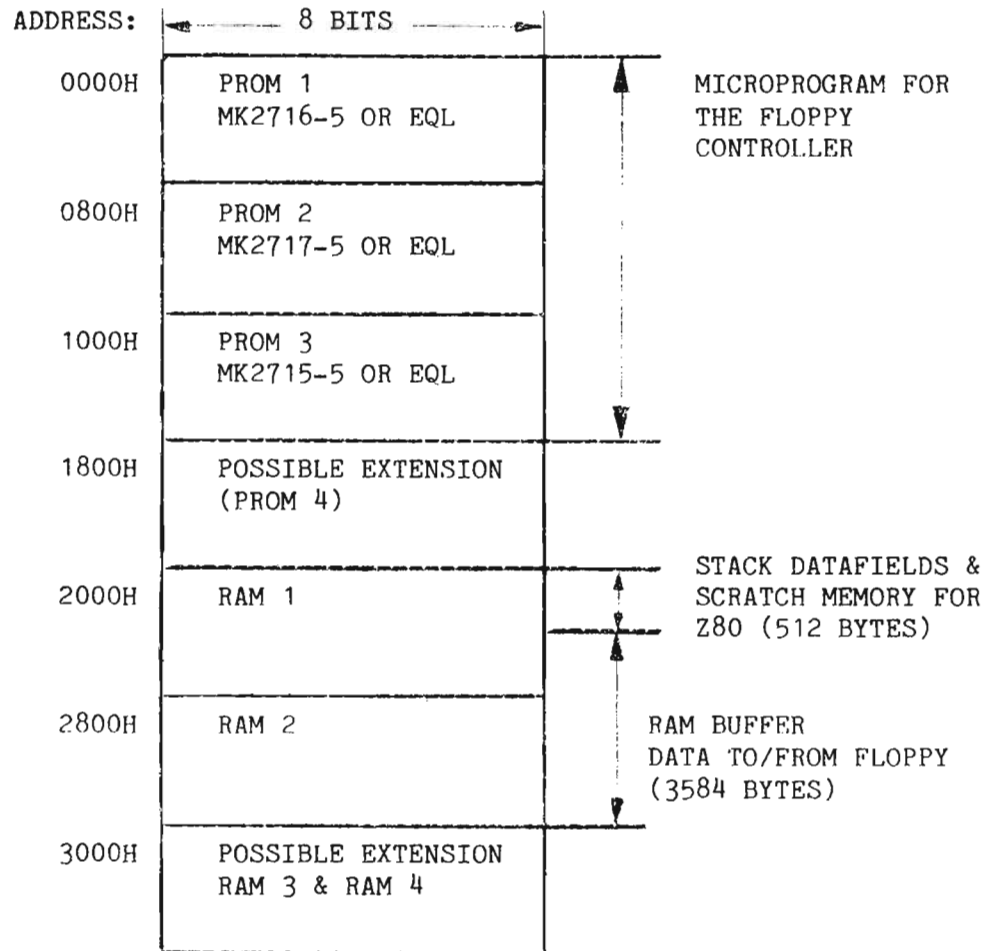

RAM 1 LAYOUT (2000H TO 27FFH)

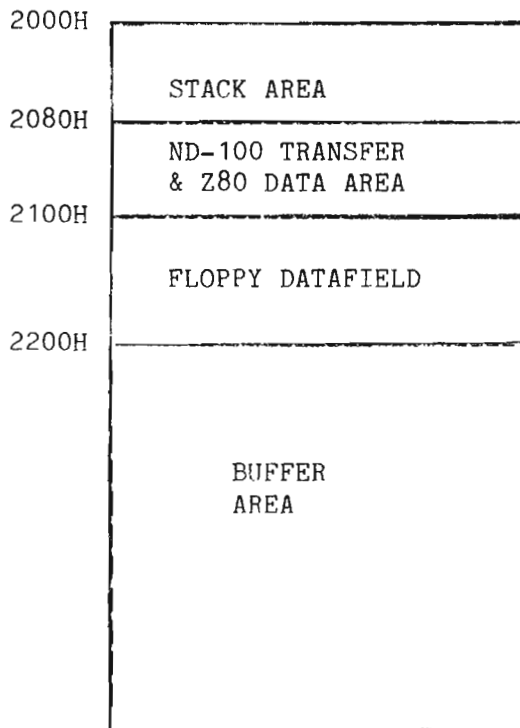

8.13.ND-100 DOUBLE DENSITY FLOPPY FORMAT

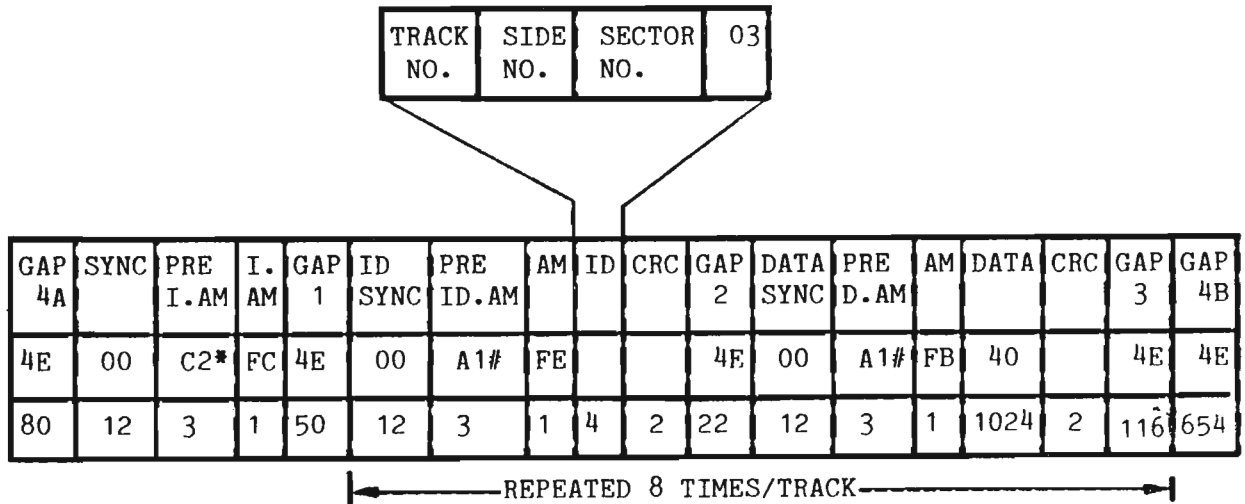

- * - C2 WITH MISSING CLOCK BETWEEN BIT 3 & 4. (DATA=C2, CLOCK=14)
- # - A1 ----- " ----- BIT 4 & 5. (DATA=A1, CLOCK=0A)

TRACKS ARE NUMBERED FROM 0 TO 76 (TOTAL OF 77 TRACKS).
 SECTORS ----- " ----- 1 TO 8 (TOTAL OF 8 SECTORS/TRACK).
 SIDES ----- " ----- 00H AND 01H.

NOTE: ALL TRACKS ON BOTH SIDES HAVE THE SAME FORMAT, THAT IS -
 TRACK 00H SIDE 00H AND TRACK 00H SIDE 01H BOTH HAVE
8 SECTORS OF 1024 BYTES.

8.14.ONE-SHOTS AND RC-DELAYS ON THE FLOPPY DISK CONTROLLER

PAGE	POSITION	TIME	COMPONENT & VALUE	COMMENTS
1	2C	1us	R27=10K, C16=220pF	MASTER CLEAR PULSE TO CONTROLLER
5	25D	35-50ms	R41=27K, C19=2,2uF	HEAD LOAD DELAY (SETTLETIME ON DRIVE)
5	25D	50-80us	R42=82K, C20=10nF	RESET PULSE TO FLOPPY CHIP (FD 1797)
5	4E	0,5us	R39=3,3K, C22=220pF	READ PULSE DUAL DENSITY 460ns < R-PULSE < 600ns
5	4E	1,0us	R40=6,8K, C23=220pF	READ PULSE SINGLE DENSITY 900ns < R-PULSE < 1200ns
5	15D	150- 200ns	R45=220 , C25=470pF	READ DATA TO FLOPPY CHIP
5		40ns	C26 AND C27	DELAY TO COMPENSATE FOR LOST MARGIN IN FD1797
5	26E	200- 300ns	R44=680 , C24=680pF	WRITE DATA PULSE
5	27F	120- 180ns	R43=390 , C21=330pF	PRECOMP TIME

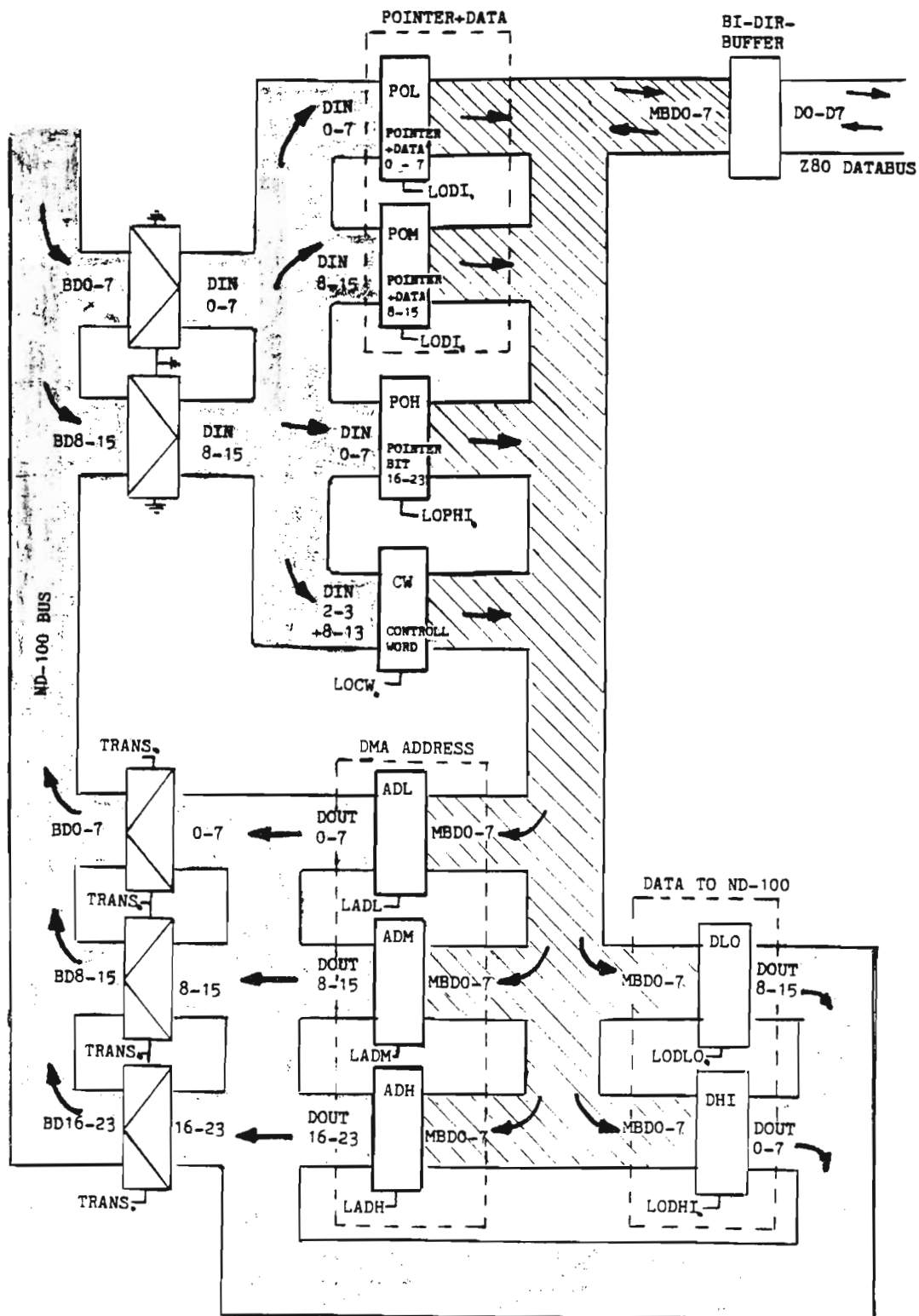

Figure 2. Registers and Buses in the ND-100 Interface.

FLOPPY DISK CONTROLLER -3027
REGISTERS IN THE FLOPPY CONTROLLER

A P P E N D I X A

MICROPROGRAM (FLOW) FOR FLOPPY-DISK-CONTROLLER

ND-11.015.01

FLMIC: MICROPROGRAM FOR FLOPPY-DISK-CONTROLLER

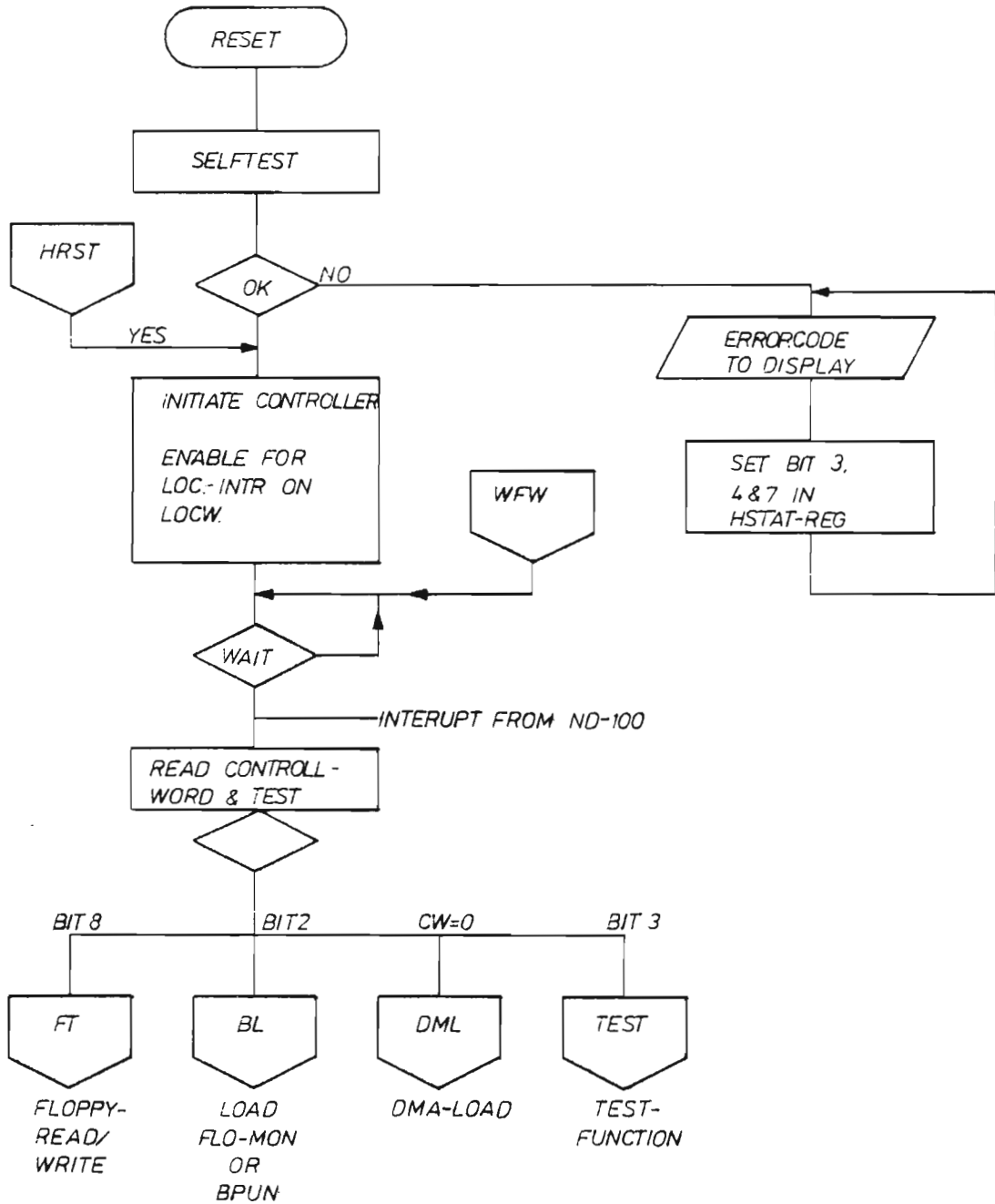

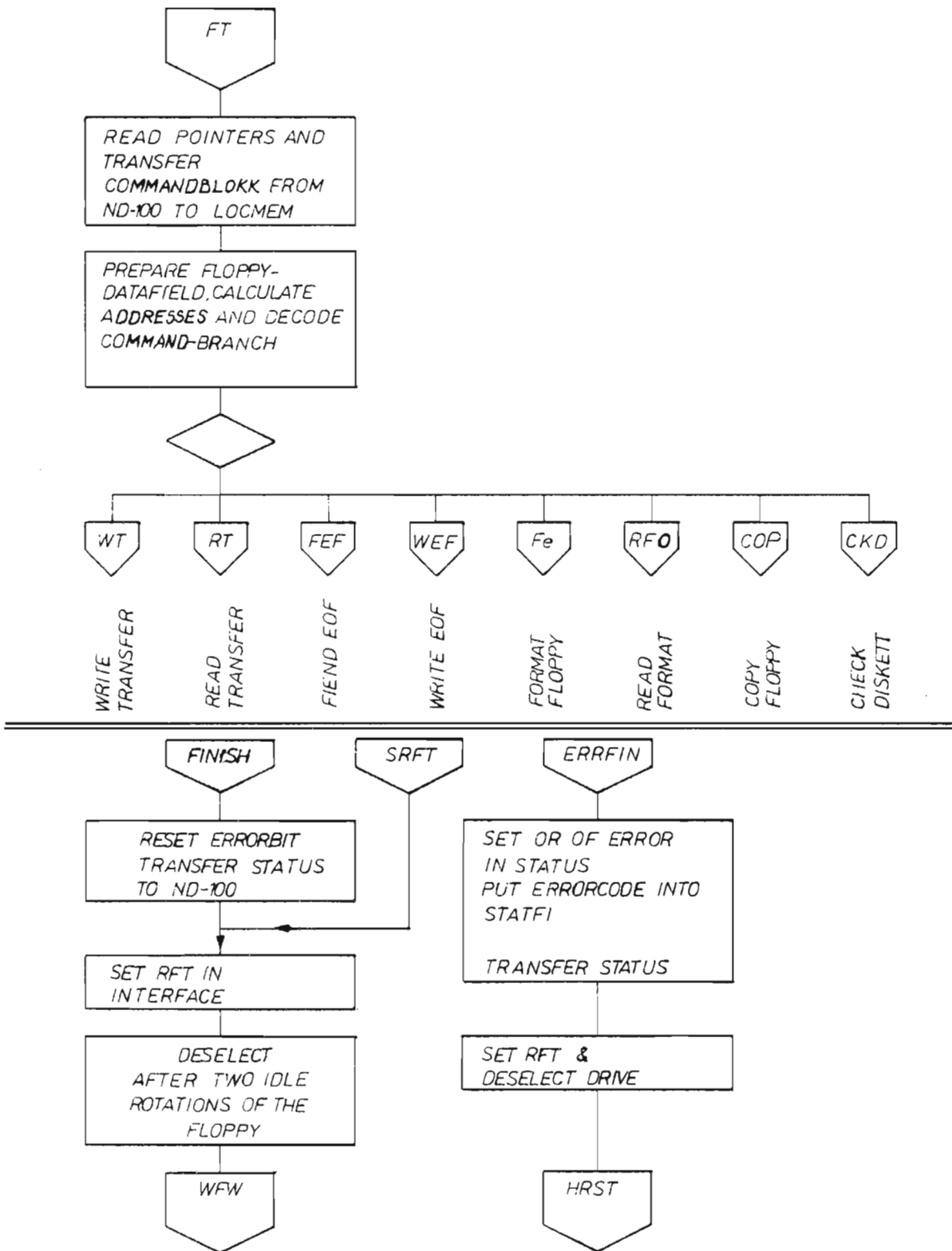

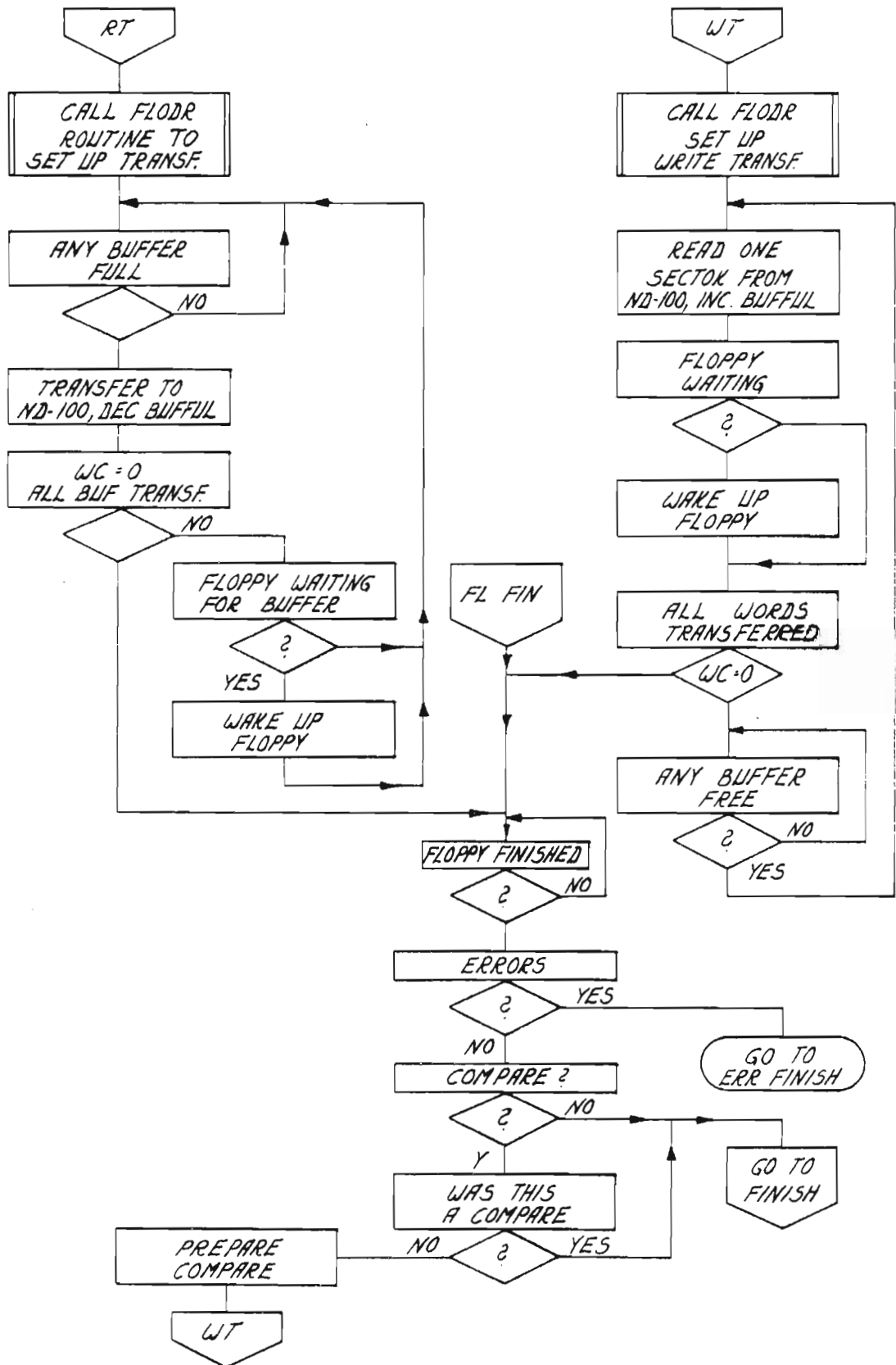

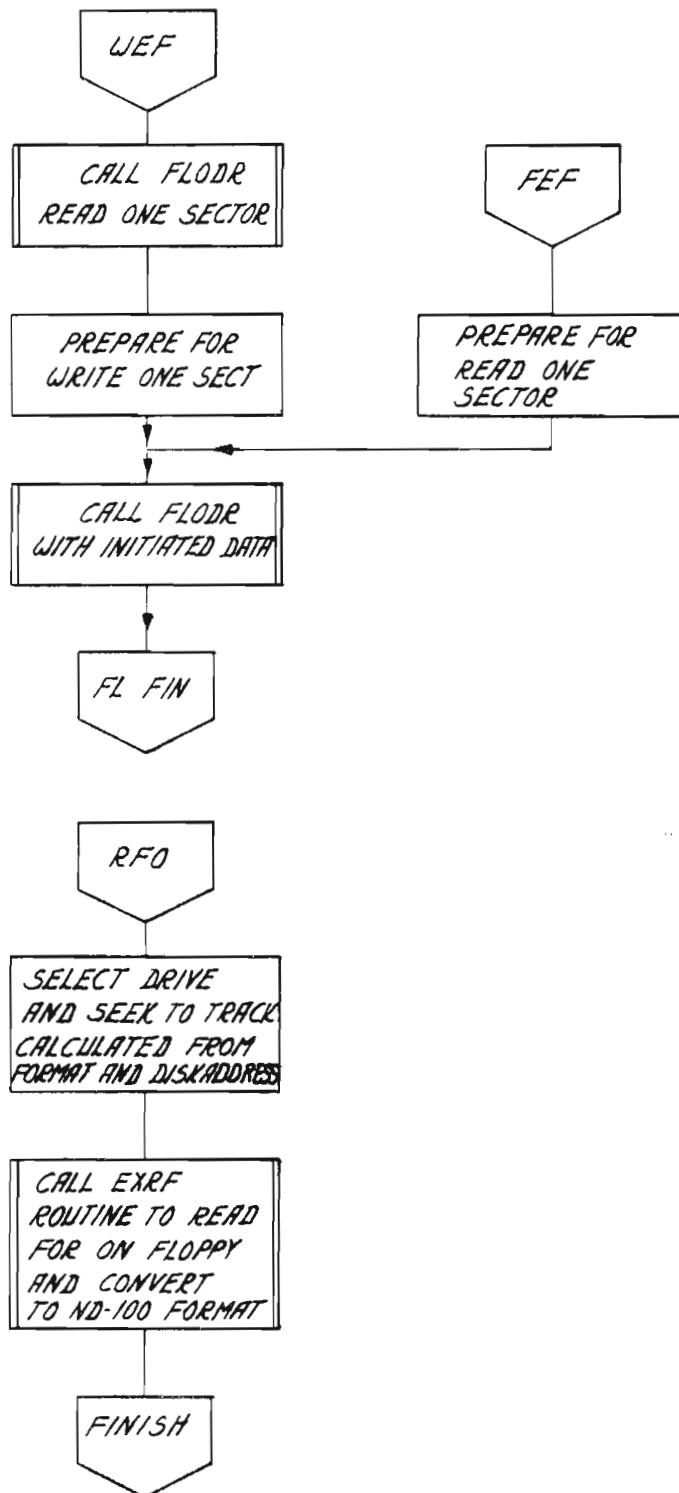

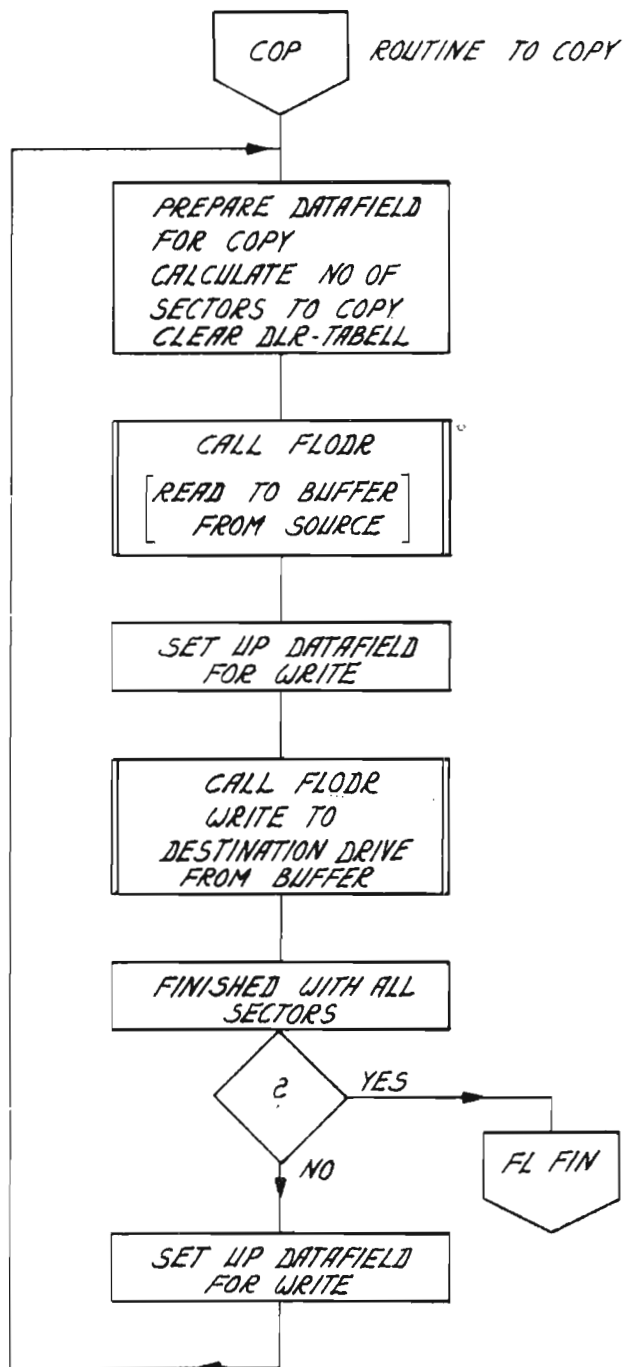

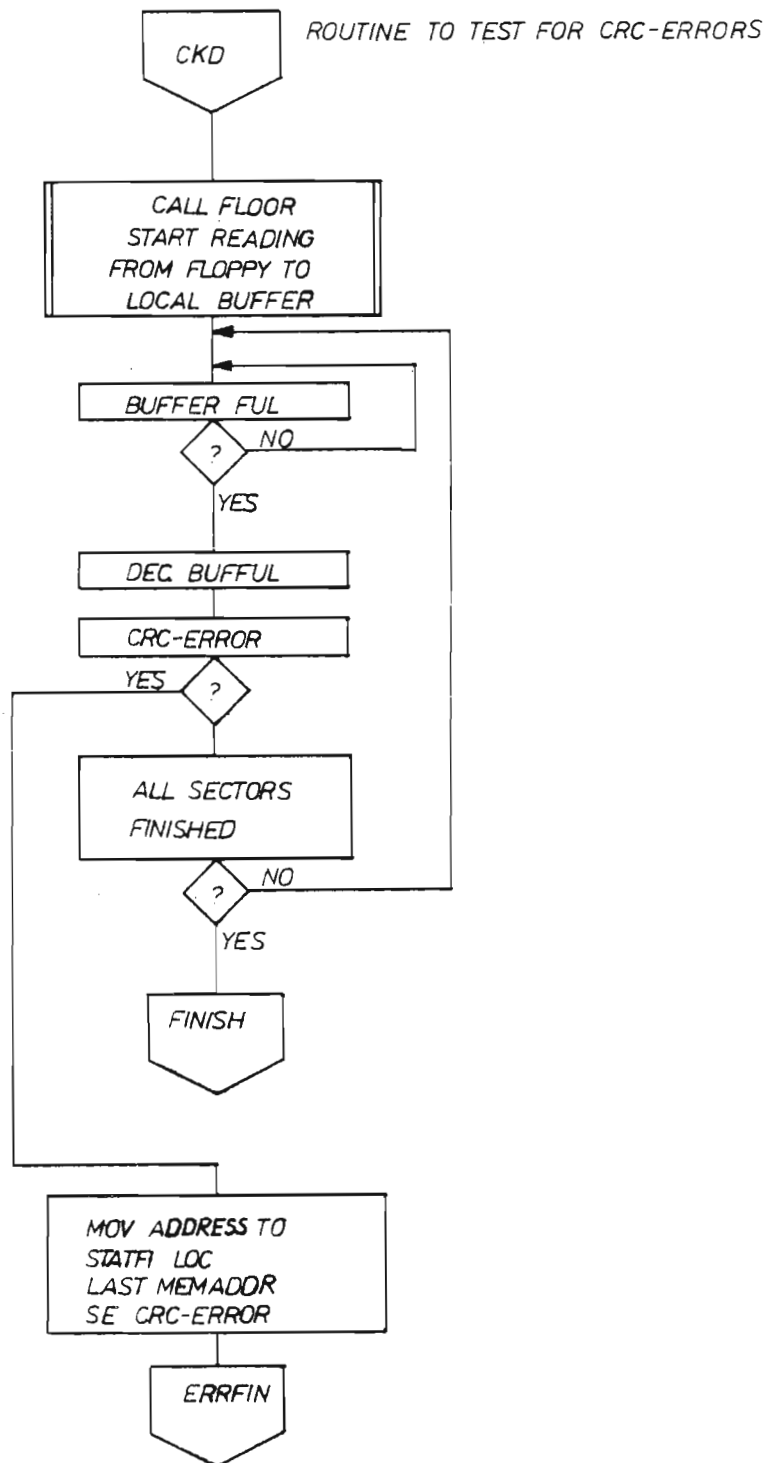

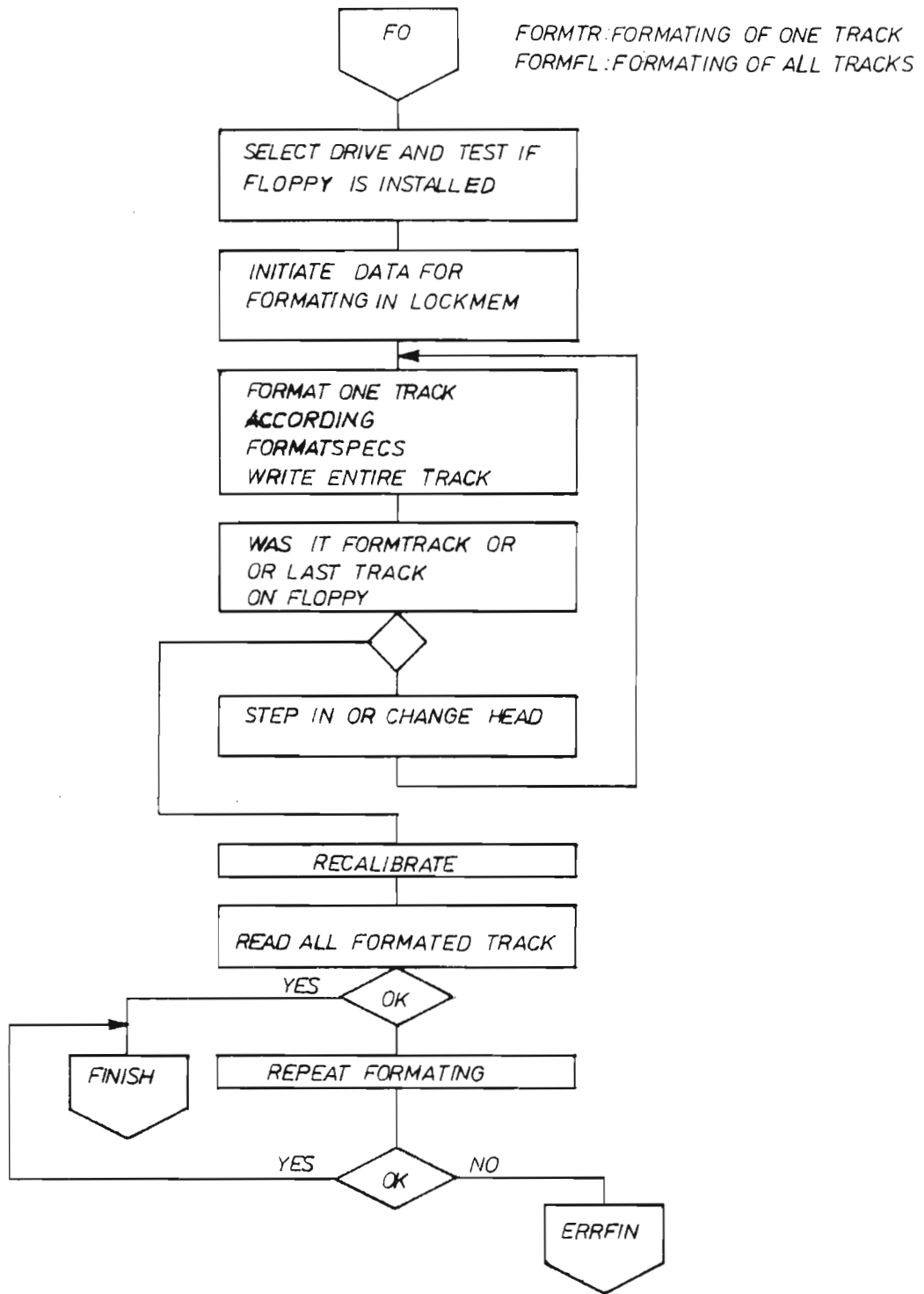

SUBROUTINE FLODR:
INTERRUPTROUTINE FLINT:

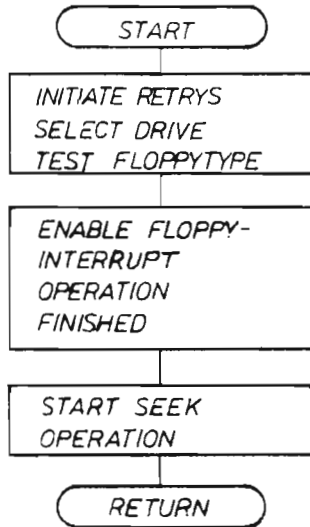

FLODR: INITIATES A FLOPPY TRANSFER.
 EACH TIME THE FLOPPY HAS
 COMPLETED AN OPERATION IT RESULTS
 IN AN INTERRUPT TO Z80- AND THE
 INT-PROG-FLINT IS STARTED.

FLINT:

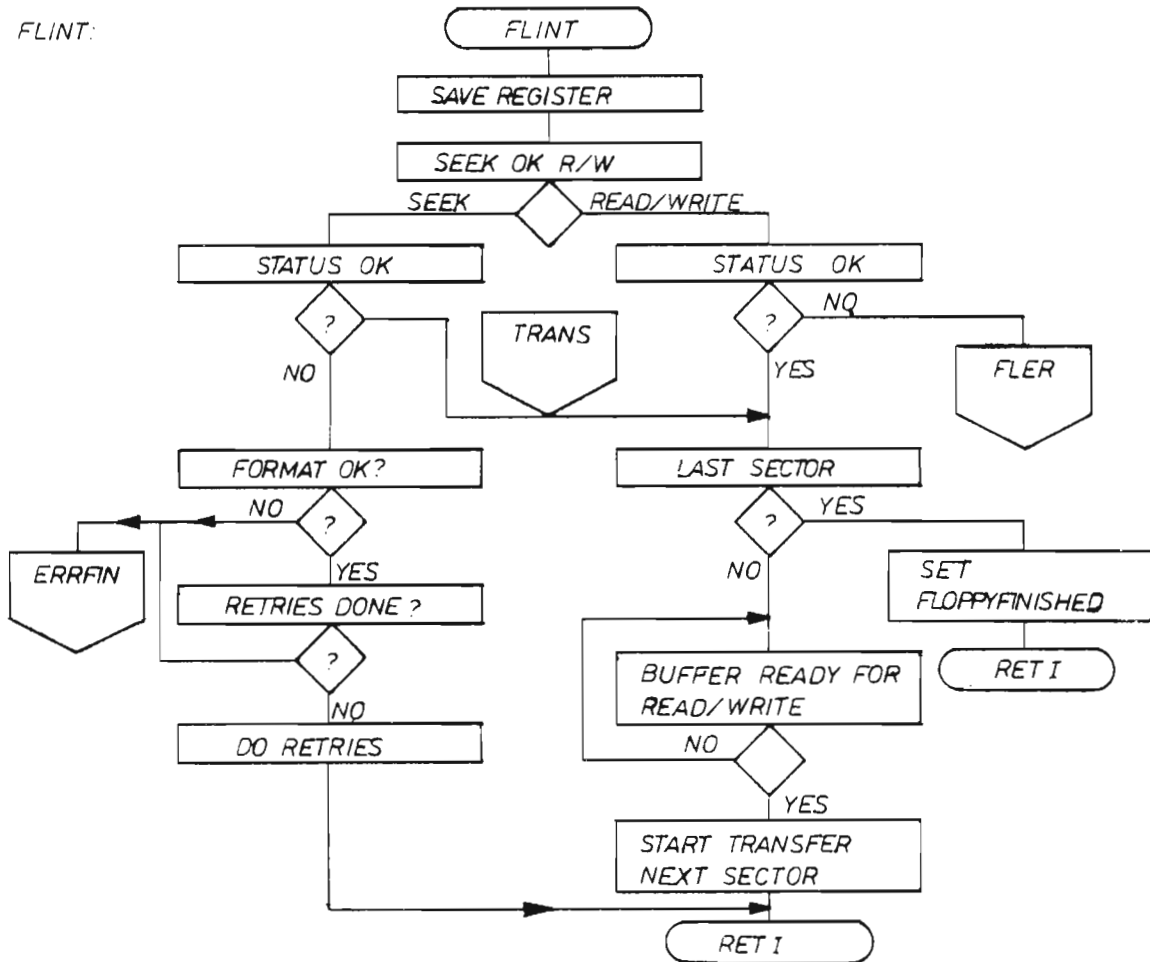

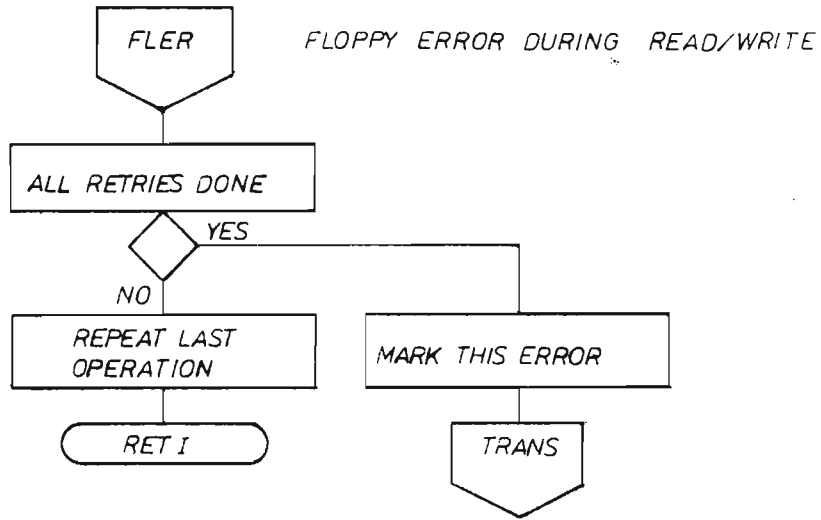

IF BIT 2 IN THE CONTROLLWORD IS SET
THEN LOAD IS EXECUTED

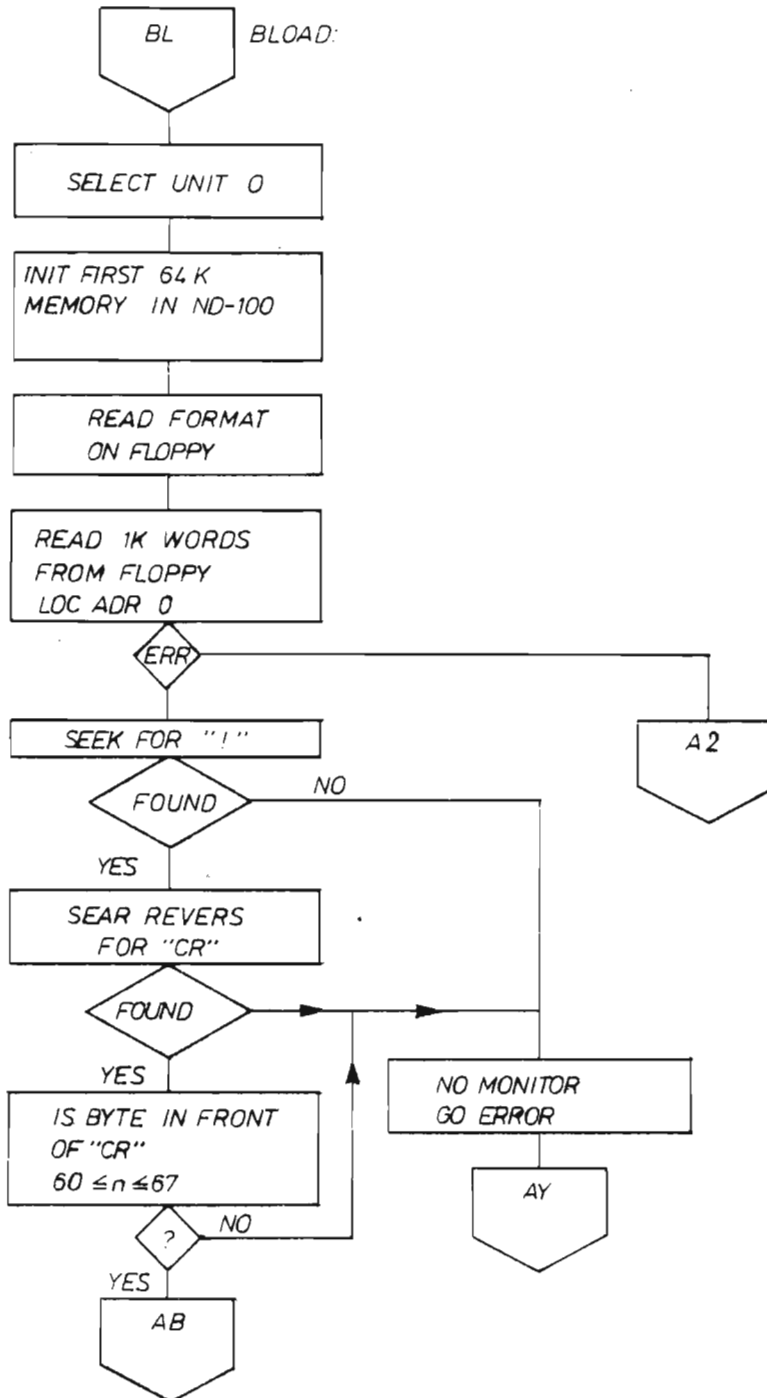

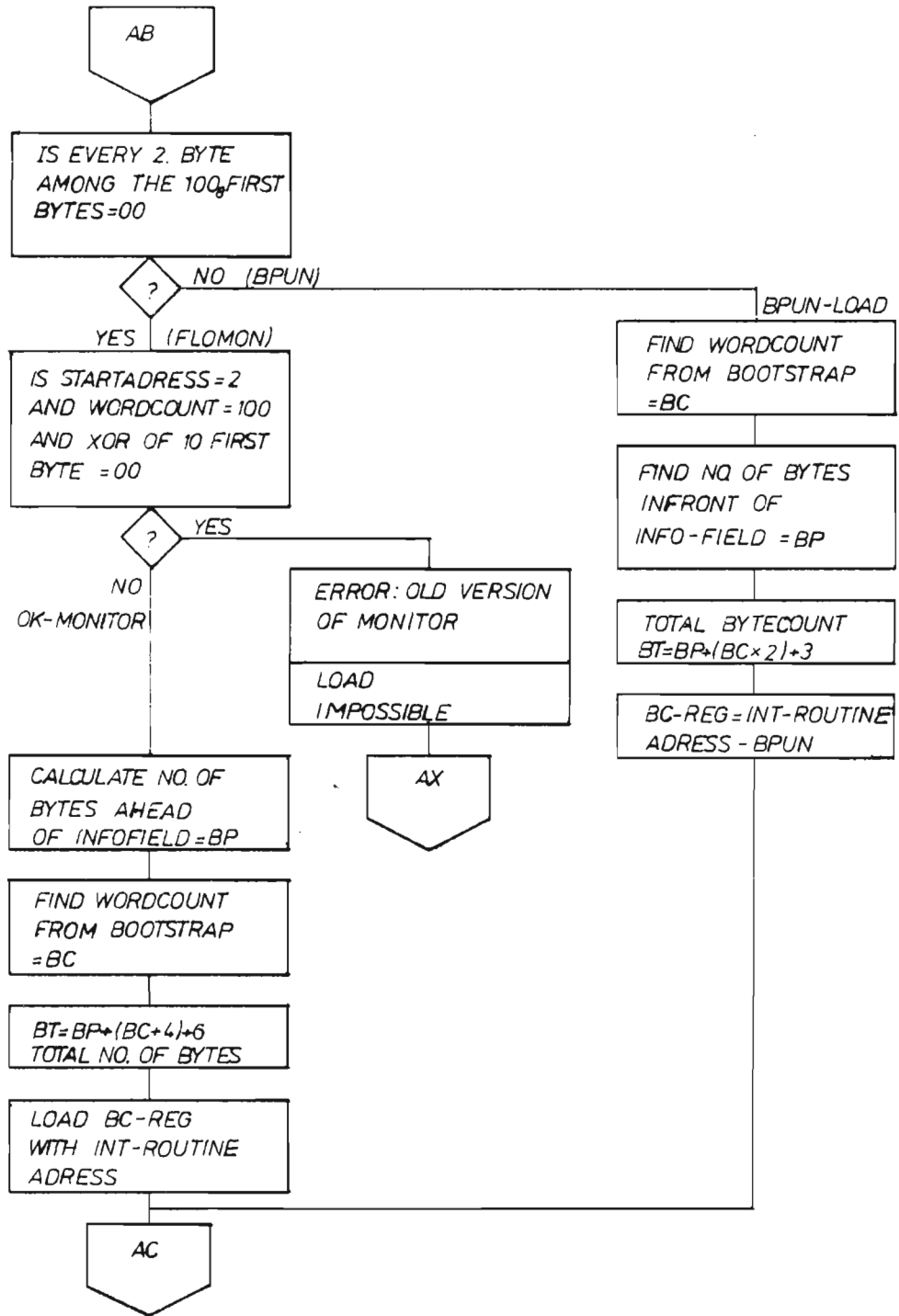

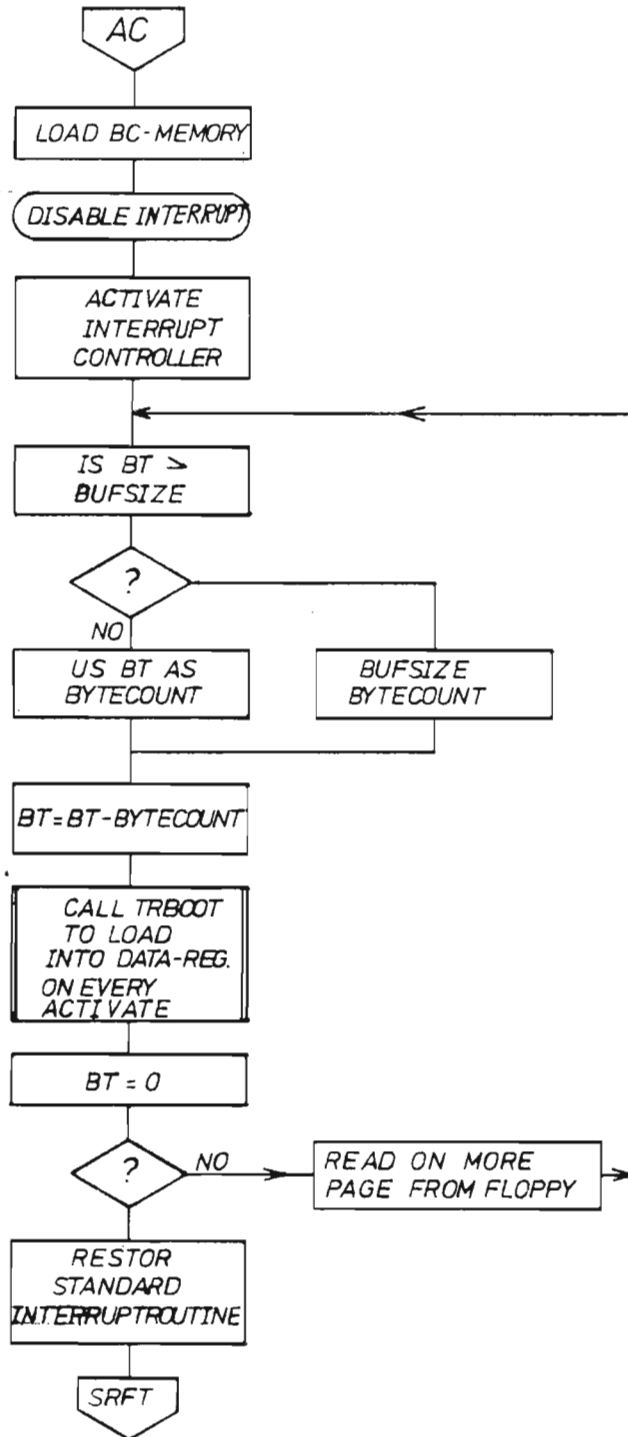

SUBROUTINE TRBOOT

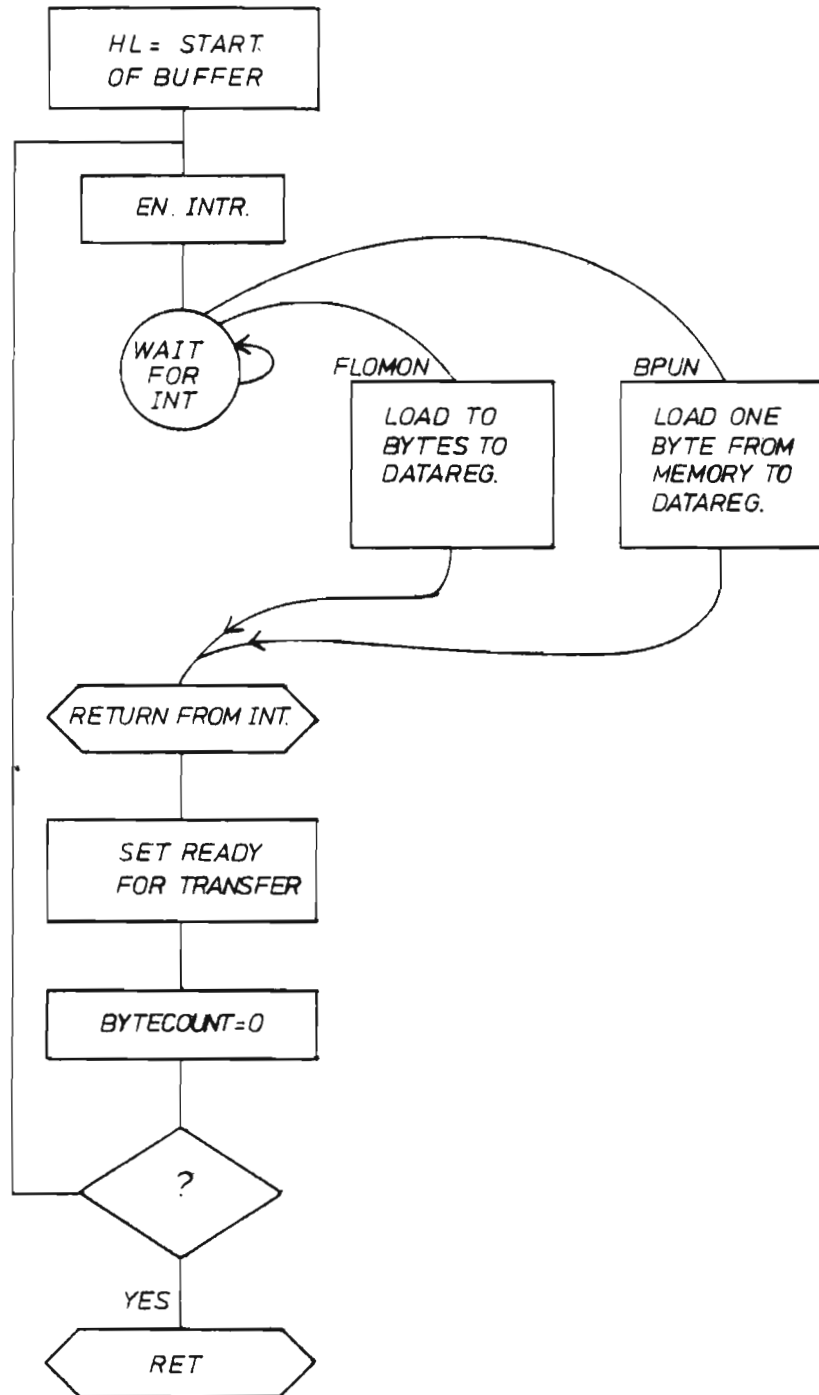

ERROR EXITS FROM LOAD

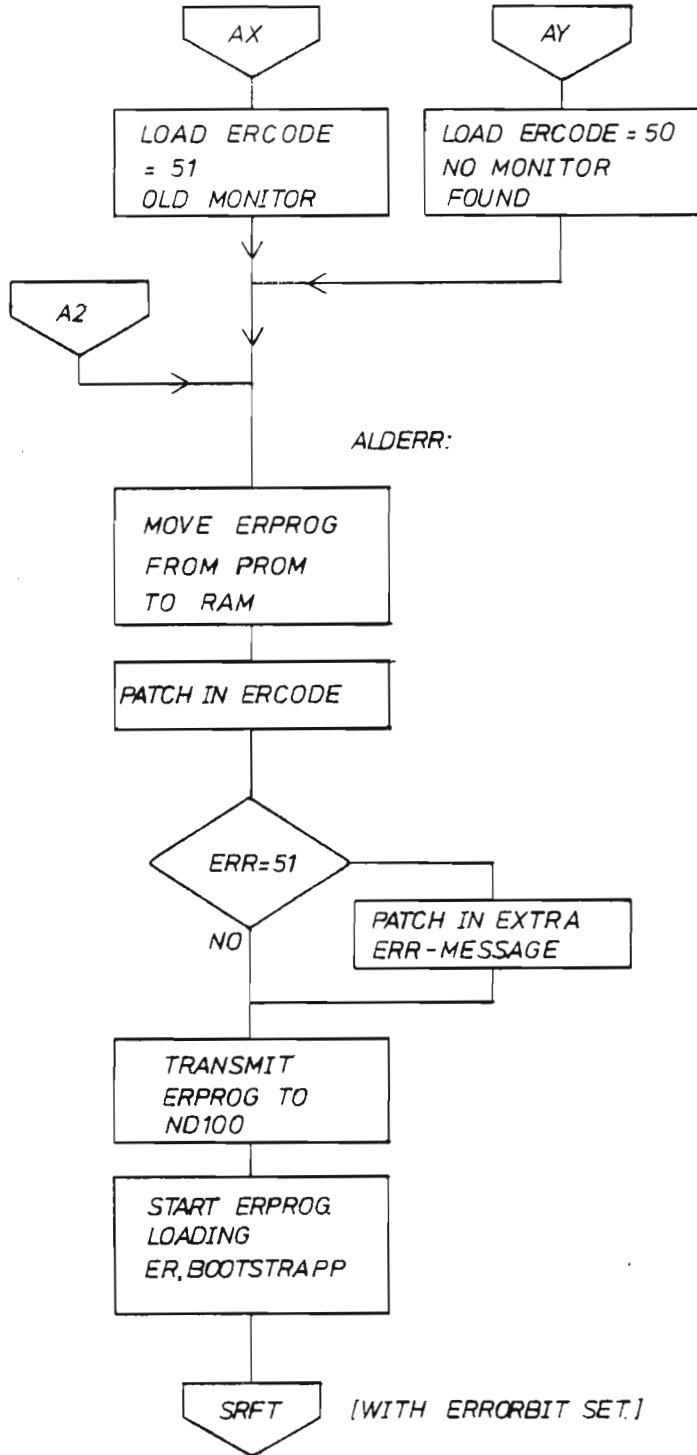

DMA-LOAD: 1024 WORDS IS
LOADED FROM START OF THE
DISKETTE TO ADR 00000₈ IN ND100
BY WRITING 21560 \$₂ ON THE
CONSOLE TERMINAL.

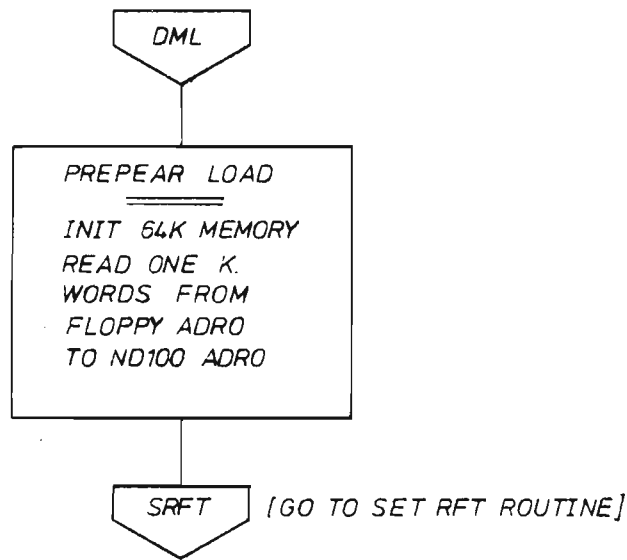

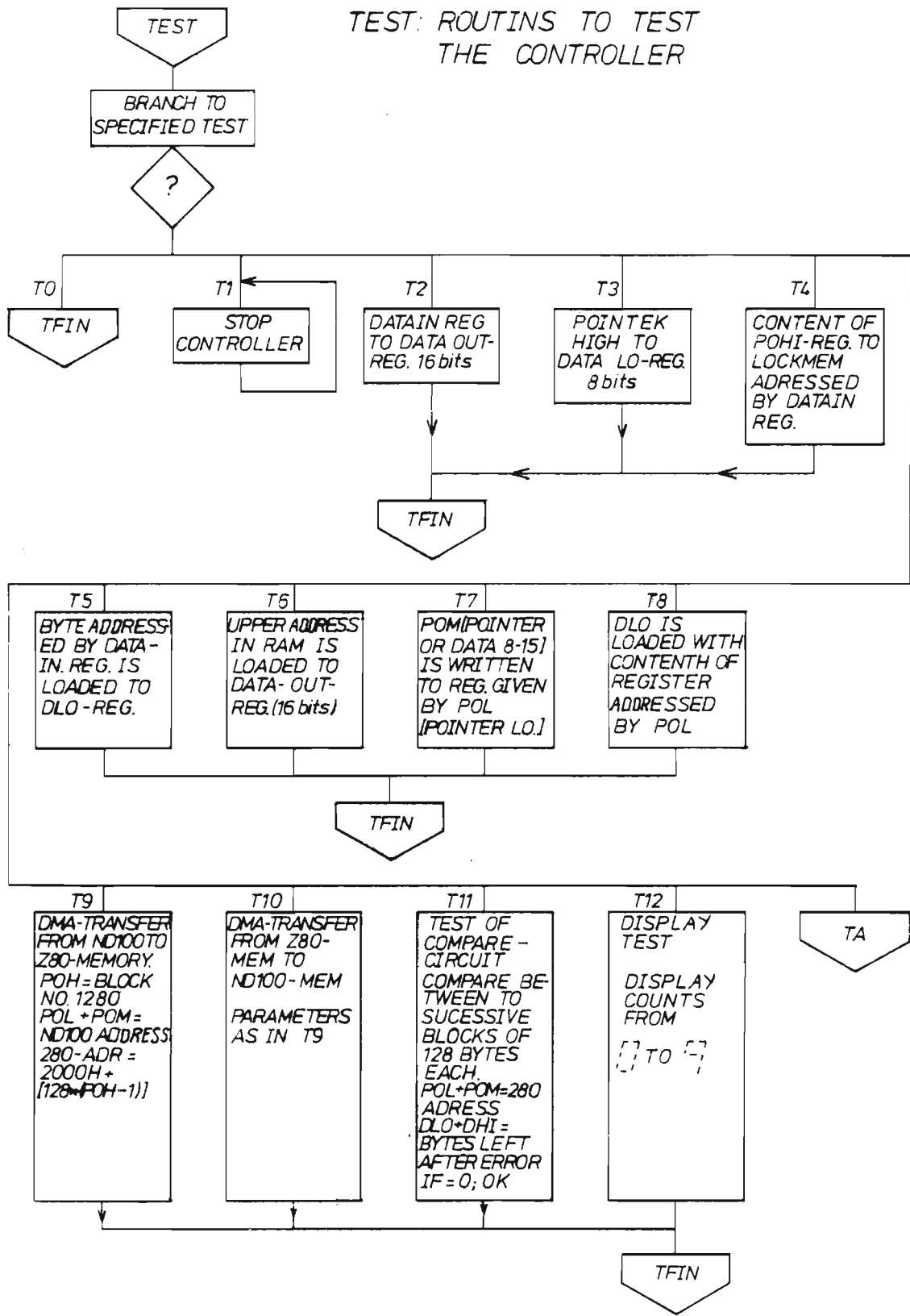

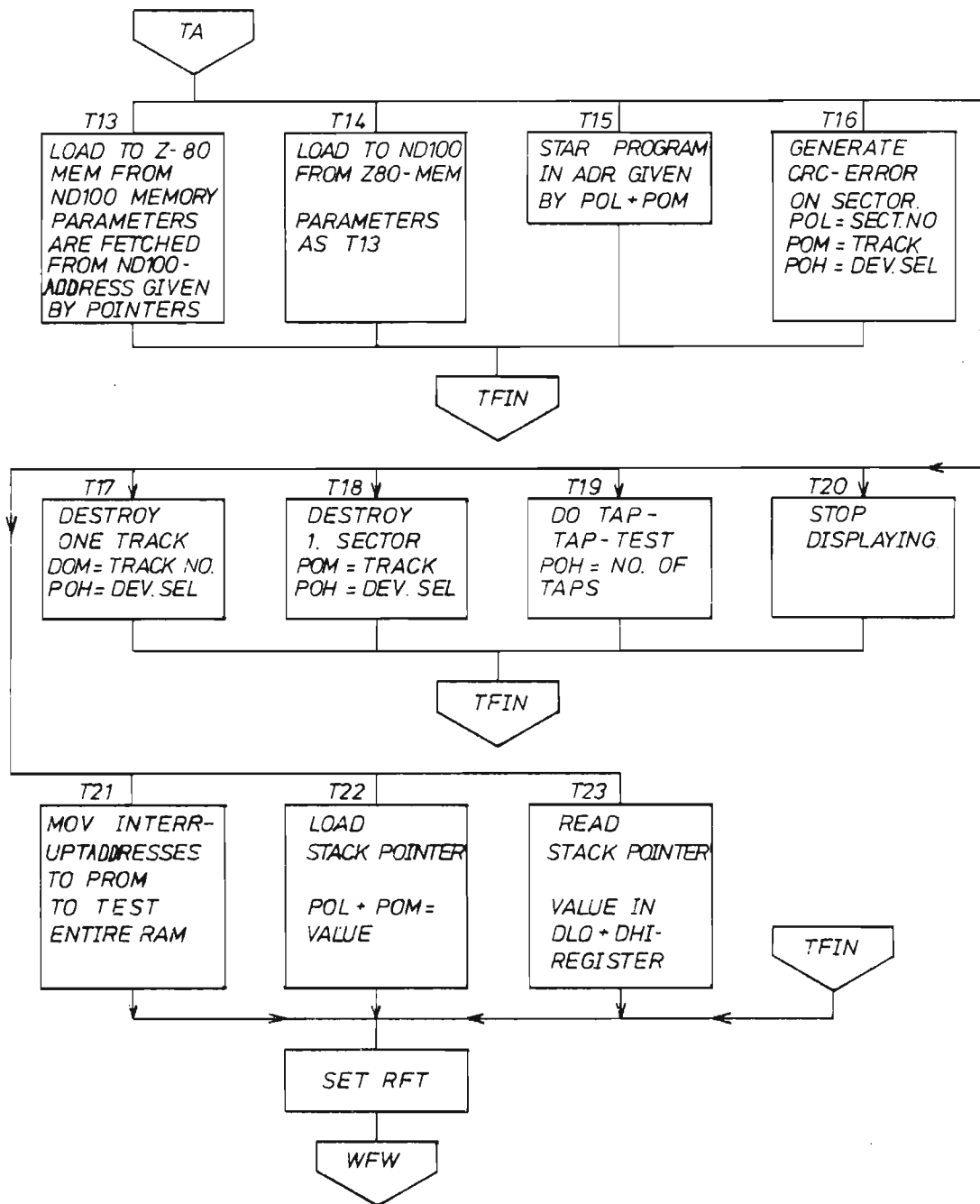

ND-11.015.01

***** **SEND US YOUR COMMENTS!!!** *****



Are you frustrated because of unclear information in this manual? Do you have trouble finding things? Why don't you join the Reader's Club and send us a note? You will receive a membership card — and an answer to your comments.

Please let us know if you

- find errors
- cannot understand information
- cannot find information
- find needless information

Do you think we could improve the manual by rearranging the contents? You could also tell us if you like the manual!



***** **HELP YOURSELF BY HELPING US!!** *****

Manual name: Floppy Disk Controller 3027

Manual number: ND-11.015.01

What problems do you have? (use extra pages if needed) _____

Do you have suggestions for improving this manual ? _____

Your name: _____ Date: _____

Company: _____ Position: _____

Address: _____

What are you using this manual for ? _____

NOTE!

This form is primarily for documentation errors. Software and system errors should be reported on Customer System Reports.

Send to:

Norsk Data A.S
Documentation Department
P.O. Box 25, Bogerud
0621 Oslo 6, Norway



Norsk Data's answer will be found on reverse side

Answer from Norsk Data

Lined area for the answer.

Answered by

Date



Norsk Data A.S
Documentation Department
P.O. Box 25, Bogerud
0621 Oslo 6, Norway

Systems that put people first

NORSK DATA A.S OLAF HELSETS VEI 5 P.O. BOX 25 BOGERUD 0621 OSLO 6 NORWAY
TEL.: 02 - 29 54 00 - TELEX: 18284 NDN